



# 6000 Series

## Escutcheons and Accessories



Legge offers a range of leading hardware furniture designs for commercial and quality residential applications.

The Legge 6000 Series will enhance the standard and elegance of any residential and commercial applications including apartments, office fitouts, hotels, and high end homes.

## Features

- Constructed of quality components, with forged brass turns and inner roses
- Suitable for use on fire door assemblies when used with fire rated locks and latches



Warranties	
Mechanical	10 years

# Specification guide

## Function

Blank rose .....	6003
Turn .....	6007
Cylinder escutcheon .....	6008
Emergency release .....	6009
Euro profile cylinder .....	6012
Indicating turn .....	6013
Indicating emergency release .....	6014
Accessible turn .....	6054
Indicating accessible turn .....	6054IND

## Finish

Antique bronze .....	A
Chrome plate .....	C
Oil rubbed bronze .....	ORB
Polished brass .....	P
Polished brass unlacquered .....	PU
Satin chrome plate .....	S
Satin black chrome .....	SBC
Satin brass .....	SB
Satin brass unlacquered .....	SBU

### 1. Function

Select the desired function e.g. cylinder escutcheon ..... 6008

### 3. Finish

Select the desired finish e.g. satin chrome plate ..... 6008S

## Finishes



**ABZ**

Antique Bronze



**CP**

Chrome Plate



**ORB**

Oil Rubbed  
Bronze



**PB/PBU**

Polished Brass/  
Unlacquered



**SCP**

Satin Chrome  
Plate

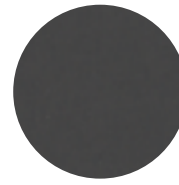

**SBC**

Satin Black  
Chrome



**SB/SBU**

Satin Brass/  
Unlacquered

## Specifications

<b>Door type</b>	Timber or metal
<b>Compatible locks/ latches</b>	Schlage ME Series mortice locks Legge 990MF Series mortice locks Legge privacy bolt (handed opposite)
<b>Fixing</b>	Surface fixed 4 x 16mm Twinfast screws
<b>Materials</b>	Forged brass levers and roses

## Handing guide

### Right Hand

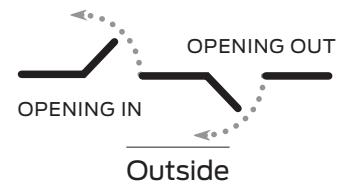

### Left Hand

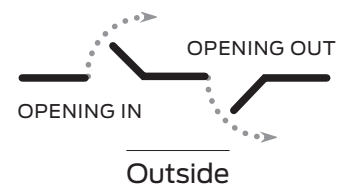

## Testing and Compliance



### Fire Rating:

Successfully tested on fire door assemblies in accordance with AS1905 Part1: Fire resistance doorsets. Check with fire door manufacturer prior to installation.



### Accessibility:

Compliant to the AS 1428:1-2009 Design for Access and Mobility

### Caution:

When door closers are installed and adjusted to meet reduced opening force requirements, there may be insufficient power to reliably close and latch the door, depending on prevailing operating conditions.

### Note:

In areas of high wind pressure and/or air conditioning pressures, the LCN Automatic Door Operators are recommended.

# Legge 6000 Series escutcheons and spare parts



Denotes handed lever/turn

## Blank rose #6003

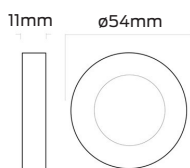

## Turn #6007

Supplied with flat tailbar  
Star spindle optional

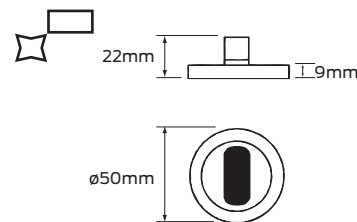

## Cylinder #6008

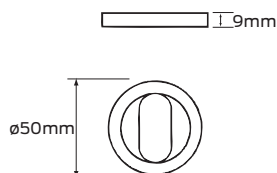

## Emergency release #6009

Works with

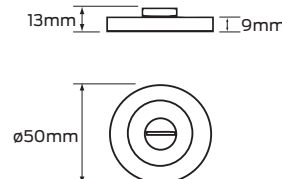

## Euro profile cylinder #6012

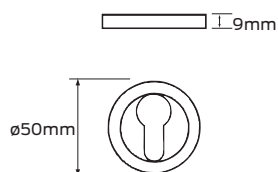

## Indicating turn #6013

Supplied with flat tailbar  
Star spindle optional

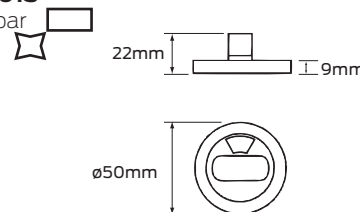

## Indicating emergency release #6014

Works with

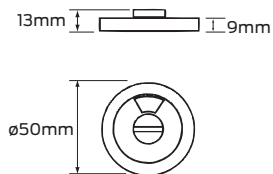

## Accessible turn #6054

Supplied with star spindle

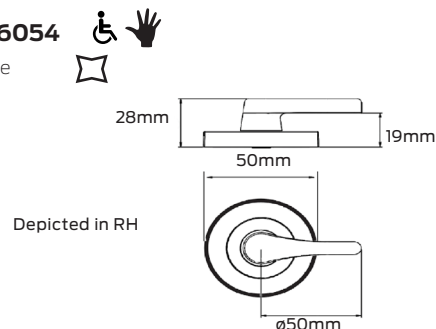

Depicted in RH

## Indicating accessible turn #6054IND

Supplied with star spindle

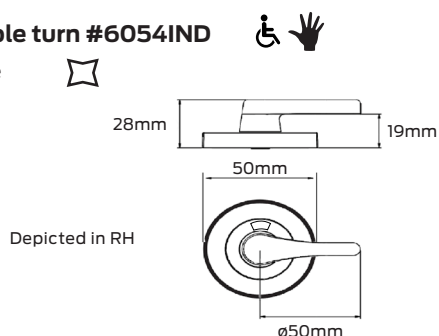

Depicted in RH

## Dummy trim fixing kit

Allows conversion of latch furniture to dummy trim function.  
One kit required per handle

