

Rose Door Handles



We take the worry out of
protecting what's valuable to you.
Lockwood: *no worries*[®]

LOCKWOOD

ASSA ABLOY

25YEAR

**MECHANICAL
WARRANTY**

www.lockweb.com.au

Contents



Robert Watson Series

Door Handles and Accessories

page 3



1220 Symphony Series

Round Rose Door Handles

page 12



1420 Symphony Series

Square Rose Door Handles

page 30



1360 Series

Round Rose Door Handles

page 48



1370 Series

Round Rose Door Handles

page 65



260 Artefact Series

Round Rose Door Handles

page 82



260SQ Series

Square Rose Door Handles

page 84



Velocity® Series

Large Rose Door Furniture

page 87



Velocity® Series

Small Rose Door Handles

page 92



Finishes

page 92

Robert Watson Series Door Handles



The Robert Watson Collection of door furniture consists of three lever designs and a range of complementing escutcheons, turnknobs and emergency release sets. The roseless design of the furniture is unprecedented and the innovation and lateral thinking involved in the development of the products has led to them being patent protected and design registered.

Application

The Robert Watson range is suitable for commercial as well as residential use.

It can be fitted with:

- Lockwood Selector 3770 Series Mortice Locks
- Lockwood Synergy 3570 Series Mortice Locks
- Lockwood 6780 and 6580 Mortice Locks (38mm backset, metal doors only)
- Lockwood 531 Latches and 6260 Tubular Bolts

Fixing

Furniture is fixed to Selector 3770 or Synergy 3570 Series Mortice Locks using a specially developed pair of steel adaptor plates that are secured through the lock case using screws.

Robert Watson furniture may also be fitted with a Lockwood 531 Latch using a steel adaptor which locates over the body of the latch.

A special adaptor for fixing Robert Watson furniture to 6780 and 6580 Narrow Style Mortice Locks in hollow aluminium door sections is also available.

Product Details

| | |
|-----------------------|--|
| Dimensions | Body: 36mm diameter. Projection from door: 62.5mm. |
| Materials | Furniture body: aluminium. Mounting stock and other internal components: stainless steel, steel and brass. |
| Door Thickness | Selector 3770 and Synergy 3570 Series: 32mm to 50mm Selector 6780 and Synergy 6580 Series: 32mm to 50mm Lockwood 531 Latches: 35mm to 50mm For Mortice Lock installation on doors 51mm to 62mm thick, use accessory pack RW00-42. |
| Finishes | Satin Anodised (SA) Powdercoat (PC) |

Standards and Compliance



Robert Watson Series has been successfully tested up to 4 hours with a fire rated Lockwood mortice lock on fire door assemblies (depending on type of doorset) in accordance with Australian Standard AS1905.1:2005, Fire Resistant Doorsets

D8

Robert Watson Series lever sets have been successfully tested to conform with Level D8 (500,000 cycles) under Australian Standard AS4145.2-2008, Locksets and hardware for doors and windows



Robert Watson Series in satin anodised finish has been successfully tested to conform with Level C10 (1000 hours) under Australian Standard AS4145.2-2008, Locksets and hardware for doors and windows

Robert Watson Series is designed, assembled and customised in Australia to suit the requirements of the Australian Market

Robert Watson Levers

Tangent - Lever A1

| | |
|-------------------------|---------|
| Length | 143 mm |
| Projection | 62.5 mm |
| Finger Clearance | 44.5 mm |

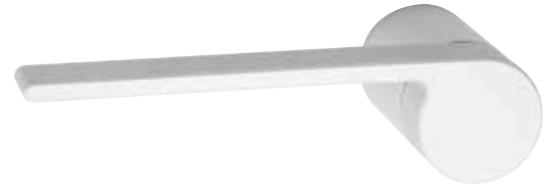
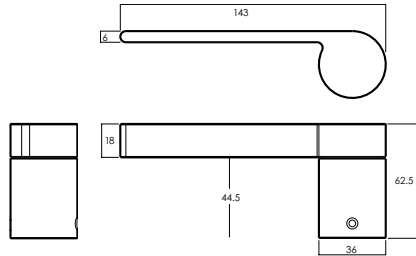

Centre - Lever A2

| | |
|-------------------------|---------|
| Length | 143 mm |
| Projection | 62.5 mm |
| Finger Clearance | 44.5 mm |

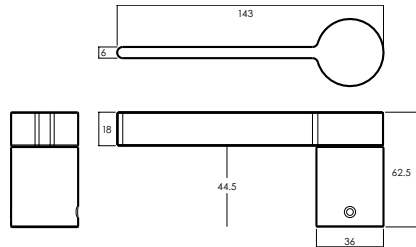

Centre D - Lever A3

| | |
|-------------------------|---------|
| Length | 143 mm |
| Projection | 62.5 mm |
| Finger Clearance | 44.5 mm |

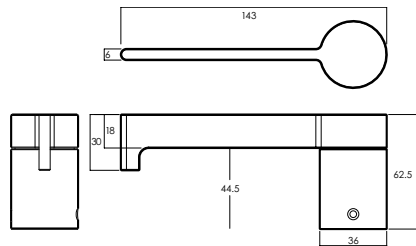

Robert Watson Series Escutcheons



These escutcheons are designed to be fitted with Lockwood oval cylinders and the Robert Watson range of turnknobs and emergency turns. Fitted using a grub screw, they ensure that the accessories they are fitted with are aesthetically pleasing.

Use with Lockwood Mortice Locks and 6260 Bolts. The escutcheons are available in different sizes for suitability to different door thicknesses.

Note: Escutcheons must be ordered separately for use with oval cylinders, turnknobs and emergency release turns.

Escutcheons

| Part Numbers | Door Thickness | (A) Dimension |
|--------------|----------------|---------------|
| RW06/38 | 35–38mm thick | 17mm |
| RW06/44 | 39–44mm thick | 14mm |
| RW06/50 | 45–50mm thick | 11mm |
| RW06/56 | 51–56mm thick* | 8mm |
| RW06/62 | 57–62mm thick* | 5mm |

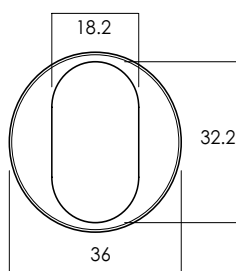

*Extended door accessory pack required if levers are to be installed on doors of this thickness.

Robert Watson Series Accessories

Turnknob

Part Number RW07

*Accessories—use with Selector 3770 and 6780 Series or Synergy 3570 and 6580 Series Mortice Locks.

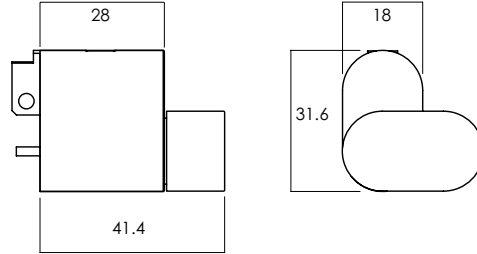

Privacy Indicating Turnknob

Part Number RW08

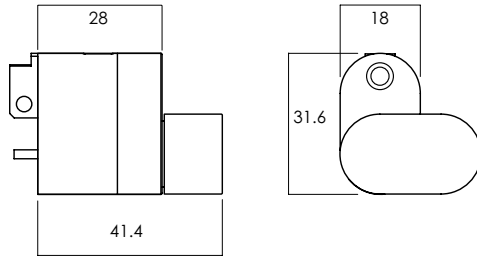

Turnknob and Emergency Release Set

Part Number RW09

*Accessories—use with Selector 3770 and 6780 Series or Synergy 3570 and 6580 Series Mortice Locks.

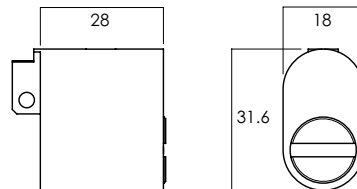

Exterior

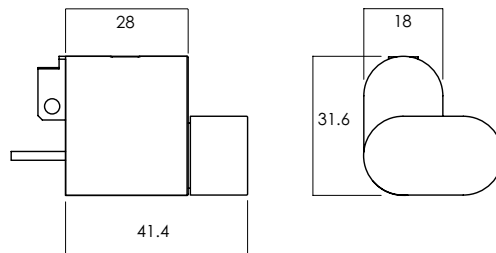

Interior

Robert Watson Series Accessories

Turnknob and Privacy Indicating Emergency Release Set

Part Number RW10

*Accessories—use with Selector 3770 and 6780 Series or Synergy 3570 and 6580 Series Mortice Locks.

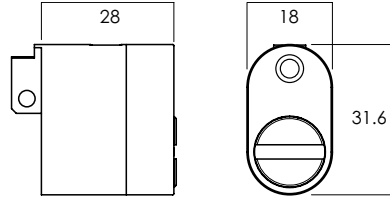

Exterior

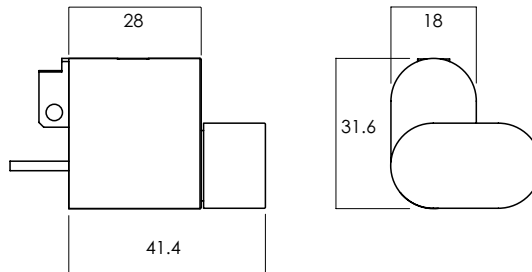

Interior

Privacy Indicating Turnknob and Privacy Indicating Emergency Release Set

Part Number RW11

*Accessories—use with Selector 3770 and 6780 Series or Synergy 3570 and 6580 Series Mortice Locks.

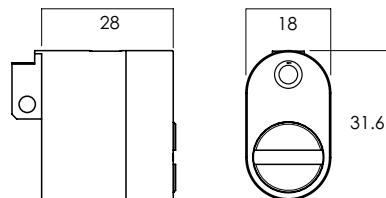

Exterior

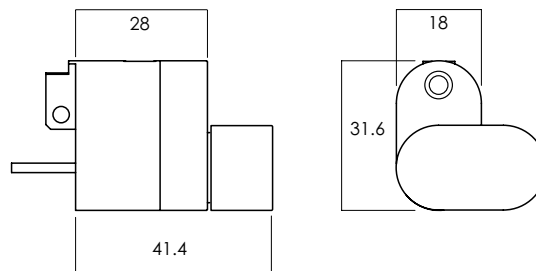

Interior

Robert Watson Series Accessories

Turnknob and Emergency Release Set

Part Number RW13

*Accessories—use with Lockwood 6260 Tubular Bolt.

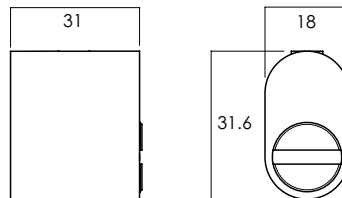

Exterior

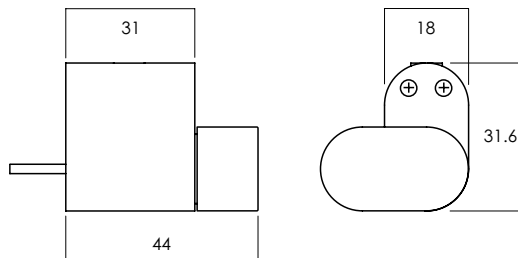

Interior

Privacy Indicating Emergency Release

Part Number RW14

*Accessories—use with Selector 3770 and 6780 Series or Synergy 3570 and 6580 Series Mortice Locks.

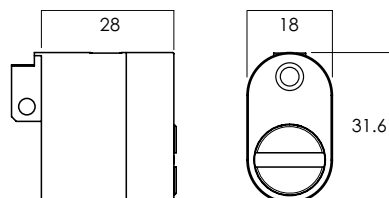

Exterior

Accessories—Latch Kits

Part Numbers (Backset) Dimension

RW531/60SC 60mm

RW531/70SC 70mm

RW531/127SC 127mm

*Latch kits are supplied with adaptors required to fit Robert Watson Levers.



Robert Watson Series Accessories

Standard turn adaptors supplied with Selector 3770 Series Mortice Locks can be used with Robert Watson turnknobs, no special adaptors needed. Simply remove the plastic insert of the turn adaptors during installation. Refer to the list below for Selector Series turn adaptors.

Selector 3770 Series Mortice Lock Turn Adaptors

| Function | Adaptor |
|-------------------|--------------|
| Locking Function | 3772-ADAPTOR |
| Latching Function | 3770-ADAPTOR |



Special adaptors are required when using Robert Watson turnknobs with Synergy Series Mortice Locks. These can be ordered as spare parts. Refer to the list below.

Synergy 3570 Series Mortice Lock Turn Adaptors

| Function | Adaptor | Function | Adaptor |
|----------|-------------|----------|-------------|
| 3570XTR | SP3570-6050 | 3572WTR | SP3572-6250 |
| 3570XTL | SP3570-6050 | 3572WTL | SP3572-6250 |
| 3570-TR | SP3570-6050 | 3572XAR | SP3572-6250 |
| 3570-TL | SP3570-6050 | 3572XAL | SP3572-6250 |
| 3571WTR | SP3571-6050 | 3573WTR | SP3571-6050 |
| 3571WTL | SP3571-6050 | 3573WTL | SP3571-6050 |
| 3571-TR | SP3571-6050 | 3573-TR | SP3571-6050 |
| 3571-TL | SP3571-6050 | 3573-TL | SP3571-6050 |
| 3572XTR | SP3572-6250 | 3574WTR | SP3572-6250 |
| 3572XTL | SP3572-6250 | 3574WTL | SP3572-6250 |
| 3572-TR | SP3572-6250 | 3574ETR | SP3572-6250 |
| 3572-TL | SP3572-6250 | 3574ETL | SP3572-6250 |

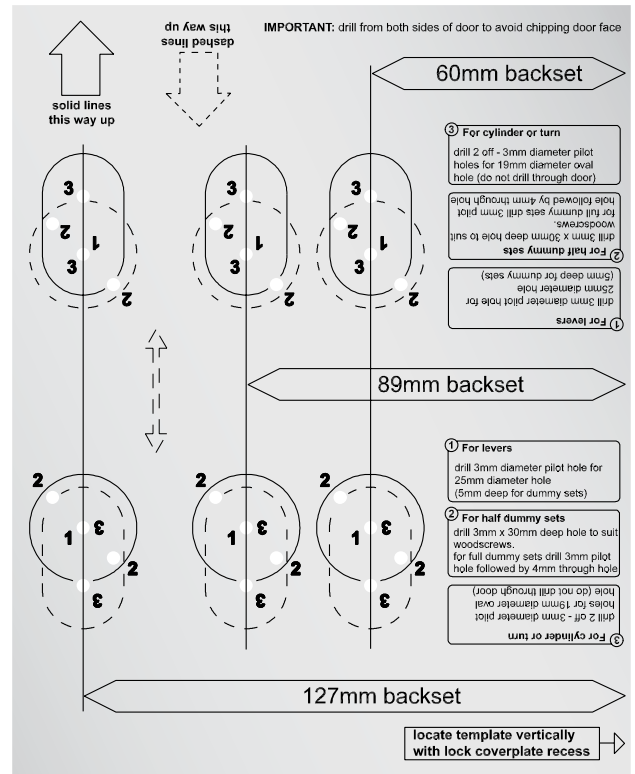

Installation Fixtures

| Part Numbers | Description |
|--------------|---|
| RW98 | Template for Lockwood 6780/6580 Series Mortice Locks (metal doors only) |
| RW99 | Template for Lockwood 3770/ 3570 Series Mortice Locks |

This stainless steel fixture makes installation easy. It is ideal when fitting furniture for large projects.

Note: Paper templates are supplied with all furniture.

Robert Watson Ordering Procedure

Ordering Procedure–Lever Sets

Sample part number RW70/01/A1LSA is made up of several sections. Choose your product by selecting an option from each section.

Robert Watson Collection

| Product | Use | Function | Lever | Handing | Finish |
|---------|-----|----------|-------|---------|--------|
| RW | 70 | 01 | A1 | L | SA |

| Product | Use | Function | Lever | Handing | Finish | | | | |
|---|-----|---|-------|----------|--------|-------------------|---|----------------|----|
| Robert Watson | RW | Operating Full Set | 00 | Tangent® | A1 | Left Handed | L | Satin Anodised | SA |
| | | Operating Half Set | 01 | Centre | A2 | Right Handed | R | Powdercoat | PC |
| | | Fixed Full Set | 02 | Centre D | A3 | * Half sets only. | | | |
| | | Fixed Half Set | 03 | | | | | | |
| Use If intended to fit using Lockwood 530 Latch | | | | | | | | | |
| If intended to fit using Lockwood 3770 and 3570 Series Mortice Locks | | Note: Latch kits are ordered separately to lever sets. i.e. for RW30/00/A1LSA as RW531/60SC is also required. | | | | | | | |
| If intended to fit using Lockwood 6780 and 6580 Narrow Style Mortice Lock (metal door only) | | These include additional mounting hardware to suit lever sets and are not the same as a standard 530 latch. | | | | | | | |
| If intended to fit to a metal door without lock | | | | | | | | | |
| If intended to fit to a timber door without lock | | | | | | | | | |

Escutcheons - Accessories

| Product | Use | Thickness | Finish |
|---------|-----|-----------|--------|
| RW | 06 | 50 | SA |

| Product | Use | Function | Finish | | |
|---------------|-----|-------------------|--------|----------------|----|
| Robert Watson | RW | Doors 57mm – 62mm | 62 | Satin Anodised | SA |
| | | Doors 51mm – 56mm | 56 | Powdercoat | PC |
| | | Doors 45mm – 50mm | 50 | | |
| | | Doors 39mm – 44mm | 44 | | |
| | | Doors 35mm – 38mm | 38 | | |

Note: Refer to the decorative finishes section at the end of this catalogue for images of the full metal finishes and powder coat colour range available.

Robert Watson Ordering Procedure

Turnknobs and Emergency release turns - Accessories (For use with Lockwood Mortice Locks)

| Product | Use | Finish |
|---------|-----|--------|
| RW | 07 | SA |

| Product | Function | Finish |
|------------------|---|-------------------|
| Robert Watson RW | Turnknob 07 | Satin Anodised SA |
| | Privacy Indicating Turnknob 08 | Powdercoat PC |
| | Turn Knob and Emergency Release Set 09 | |
| | Turnknob/Privacy Indicating Emergency Release Set 10 | |
| | Privacy Indicating Turnknob and Privacy Indicating Emergency Release Set 11 | |
| | Privacy Indicating Emergency Release 14 | |

Turnknob and Emergency Release Turns - Accessories (For use with Lockwood 6260 Tubular Bolts)

| Product | Function | Finish |
|---------|----------|--------|
| RW | 13 | SA |

| Product | Function | Finish |
|------------------|---------------------------------------|-------------------|
| Robert Watson RW | Turnknob and Emergency Release Set 13 | Satin Anodised SA |
| | | Powdercoat PC |

Latch Kits - Accessories

| Product | Latch | Backset | Finish |
|---------|-------|---------|--------|
| RW | 531 | 60 | SC |

| Product | Latch | Function | Finish |
|------------------|-----------------|-------------------|-----------------|
| Robert Watson RW | Plain Latch 531 | 60mm backset 60 | Satin Chrome SC |
| | | 70mm backset 70 | |
| | | 127mm backset 127 | |

Latch Kits are supplied with adaptor to enable use with Robert Watson Furniture.

Note: Refer to the decorative finishes section at the end of this catalogue for images of the full metal finishes and powder coat colour range available.

1220 Symphony Series Brass Door Handles



Lockwood Symphony Series door furniture is manufactured from high quality solid brass. The comprehensive lever range matched with concealed screw fixings by way of threaded rose trims, provides a stylish look for the most elegant interiors.

The accessory range includes cylinder escutcheons, emergency turnknob and disabled accessible turnknobs. For installers, the unique turn mechanism adjusts to suit the thickness of the door and removes the need to cut tailbars to length.

A full range of finishes from satin chrome through to a range of brass finishes and polyester powder coat provides all the options for matching to interior designs.

Proudly Australian Made at our factory in Oakleigh to the highest quality standards for strength, durability and corrosion resistance.

Product Details

| | |
|----------------------------|--|
| Dimensions | 53mm diameter x 11.6mm. |
| Handing | A removable stop screw allows all symmetrically designed levers (e.g. Cadenza) to be handed on site. Levers of asymmetrical design (e.g. Veloce) cannot be reversed. Specify left or right handed when ordering. |
| Materials | All Lockwood roses and levers contained in the 1220 series are of solid brass construction. |
| Fixing | Fully concealed on both sides. |
| Door Thickness | Selector 3770 and Synergy 3570 Series: 32mm to 50mm Lockwood 5260 Latches: 33mm to 50mm |
| Decorative Finishes | <p>Standard Finish: Satin Chrome Brushed (SC)</p> <p>Non-Standard Finish: Chrome Plate (CP) Polished Brass (PB) Polyester Powdercoat (PC)</p> <p>Special Finish: Architectural Bronze (AZ) Architectural Bronze Unlacquered (AU) Antique Copper (AC) Polished Brass Unlacquered (BU) Satin Brass (SB) Oil Rubbed Bronze (ORB) Satin Brass Unlacquered (SBU)</p> |
| Privacy | Privacy function for Symphony Round Rose Furniture is achieved using the 3890 privacy adaptor and the Symphony 1321 interior rose. See ordering procedure for details. |

Standards and Compliance



1220 Series has been successfully tested up to 4 hours with a fire rated Lockwood mortice lock on fire door assemblies (depending on type of doorset) in accordance with Australian Standard AS1905.1:2005, Fire Resistant Doorsets

D8

1220 Series lever sets have been successfully tested to conform with Level D8 (500,000 cycles) under Australian Standard AS4145.2-2008, Locksets and hardware for doors and windows



1220 Series lever sets in satin chrome finish has been successfully tested to AS 4145.2 2008 for Neutral Salt Spray – with SC Finish passing C10 1000 Hours - Extreme Corrosion Resistance. Suitable for coastal applications



1220 Series includes levers and turns (as shown) that meet the requirements of AS1428.1-2009, Design for access and mobility

Lockwood Brass Door Furniture is designed, assembled and customised in Australia to suit the requirements of the Australian Market.

1220 Symphony Series Brass Door Handles

BRASS CORE

The Symphony Series rose furniture features a 53mm solid brass rose with horizontal screw fixings, concealed on both sides by a threaded rose trim.

Supplied with:

2 x M4 x 65mm Stainless Steel Screws (SP1220-119)
1 x Instructions (1220-221)

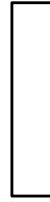
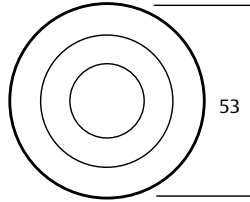

12

AS1428.1 Compliant Levers

Lever 102

| | |
|-------------------------|---------|
| Length | 134.3mm |
| Projection | 57.5mm |
| Finger clearance | 28.4mm |

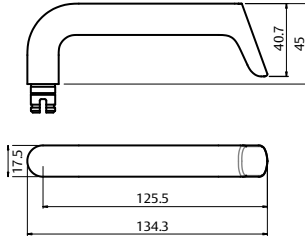

Lever 111

| | |
|-------------------------|--------|
| Length | 130mm |
| Projection | 48.5mm |
| Finger clearance | 28.4mm |

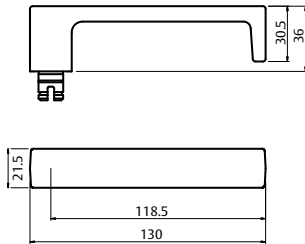

Lever 112

| | |
|-------------------------|---------|
| Length | 130.5mm |
| Projection | 48mm |
| Finger clearance | 28.4mm |

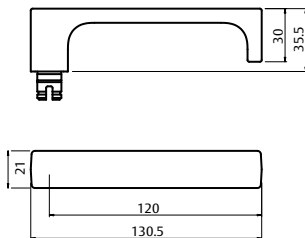

1220 Symphony Series Brass Door Handles

AS1428.1 Compliant Levers

Lever 115

| | |
|-------------------------|---------|
| Length | 140.4mm |
| Projection | 60mm |
| Finger clearance | 28.4mm |

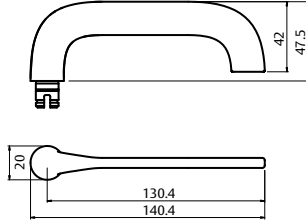

Lever 116

| | |
|-------------------------|---------|
| Length | 140.5mm |
| Projection | 47.6mm |
| Finger clearance | 28.4mm |

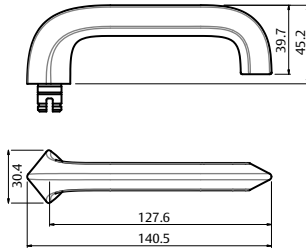

Lever 118

| | |
|-------------------------|--------|
| Length | 128mm |
| Projection | 58mm |
| Finger clearance | 28.4mm |

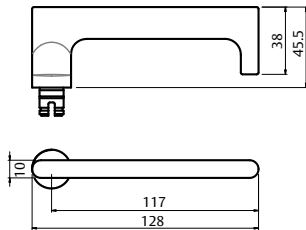

Lever 124

| | |
|-------------------------|---------|
| Length | 130.5mm |
| Projection | 59mm |
| Finger clearance | 28.4mm |

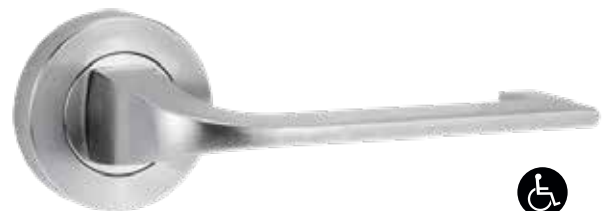
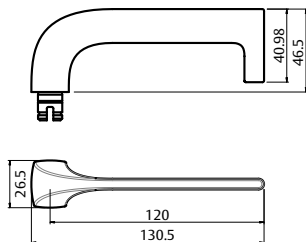

1220 Symphony Series Brass Door Handles

AS1428.1 Compliant Levers

Lever 131

| | |
|-------------------------|---------|
| Length | 134.5mm |
| Projection | 53mm |
| Finger clearance | 28.4mm |

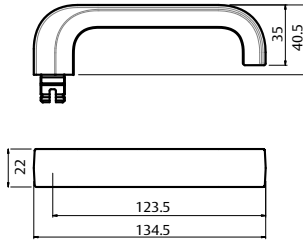

Lever 132

| | |
|-------------------------|--------|
| Length | 130mm |
| Projection | 57.5mm |
| Finger clearance | 28.4mm |

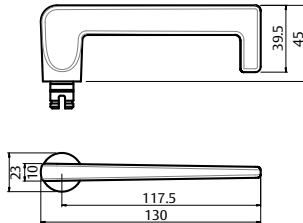

Lever 133

| | |
|-------------------------|--------|
| Length | 130mm |
| Projection | 53.5mm |
| Finger clearance | 28.4mm |

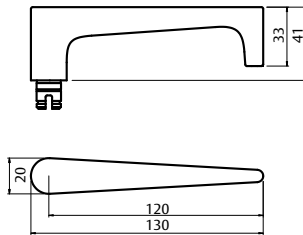

Lever 142

| | |
|-------------------------|---------|
| Length | 130.5mm |
| Projection | 55mm |
| Finger clearance | 28.4mm |

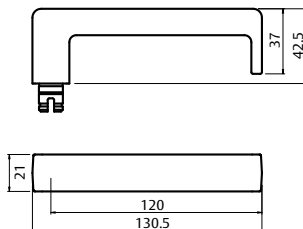

1220 Symphony Series Brass Door Handles

AS1428.1 Compliant Levers

Lever 144

| | |
|-------------------------|---------|
| Length | 128.8mm |
| Projection | 57.5mm |
| Finger clearance | 28.4mm |

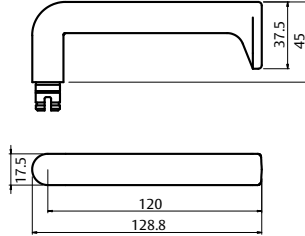

Lever 145

| | |
|-------------------------|--------|
| Length | 130mm |
| Projection | 58.5mm |
| Finger clearance | 28.4mm |

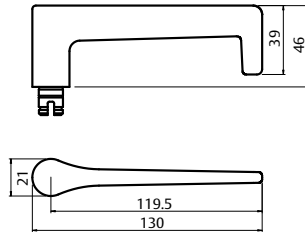

Lever 155

| | |
|-------------------------|---------|
| Length | 129.3mm |
| Projection | 57.5mm |
| Finger clearance | 28.4mm |

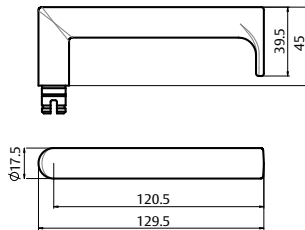

Lever 166

| | |
|-------------------------|--------|
| Length | 130mm |
| Projection | 48mm |
| Finger clearance | 28.4mm |

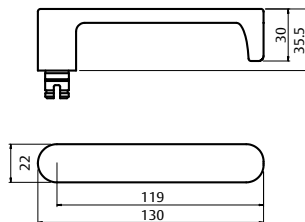

1220 Symphony Series Brass Door Handles

AS1428.1 Compliant Levers

Lever 180

| | |
|-------------------------|---------|
| Length | 123.5mm |
| Projection | 53.1mm |
| Finger clearance | 28.4mm |

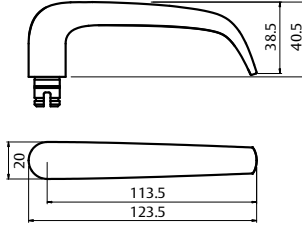

Lever 47

| | |
|-------------------------|--------|
| Length | 120mm |
| Projection | 49.6mm |
| Finger clearance | 40mm |

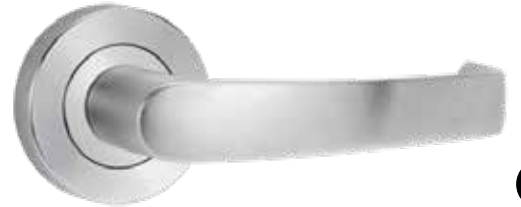
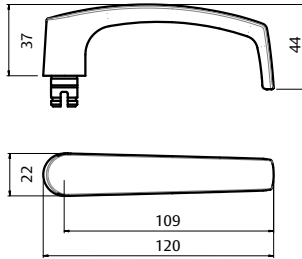

Lever 59

| | |
|-------------------------|--------|
| Length | 121mm |
| Projection | 57.5mm |
| Finger clearance | 38mm |

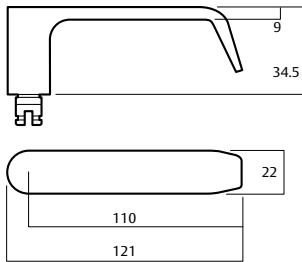

Lever 70

| | |
|-------------------------|-------|
| Length | 121mm |
| Projection | 53mm |
| Finger clearance | 37mm |

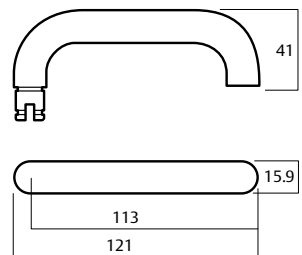

1220 Symphony Series Brass Door Handles

AS1428.1 Compliant Levers

Lever 74

| | |
|-------------------------|-------|
| Length | 120mm |
| Projection | 53mm |
| Finger clearance | 45mm |

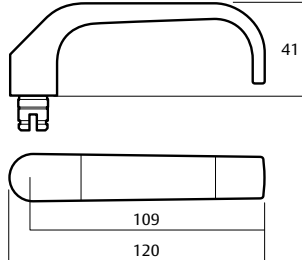

Lever 76

| | |
|-------------------------|--------|
| Length | 125mm |
| Projection | 48.5mm |
| Finger clearance | 28.4mm |

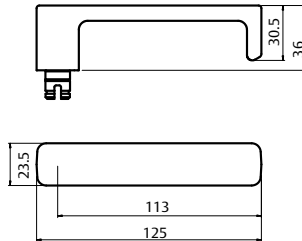

Lever 77

| | |
|-------------------------|--------|
| Length | 121mm |
| Projection | 51mm |
| Finger clearance | 40.5mm |

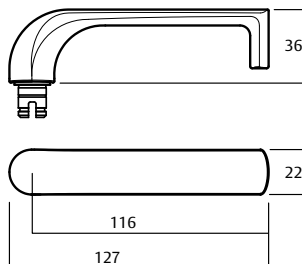

Lever 90

| | |
|-------------------------|---------|
| Length | 118.5mm |
| Projection | 52mm |
| Finger clearance | 45mm |

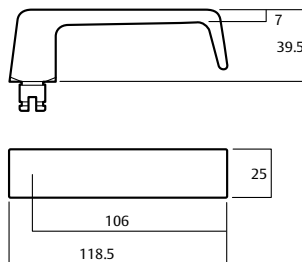

1220 Symphony Series Brass Door Handles

Non compliant lever/knob types

Lever 101

| | |
|-------------------------|--------|
| Length | 130mm |
| Projection | 48.5mm |
| Finger clearance | 28.4mm |

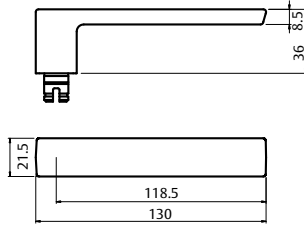

Lever 104

| | |
|-------------------------|---------|
| Length | 133.8mm |
| Projection | 57.5mm |
| Finger clearance | 28.4mm |

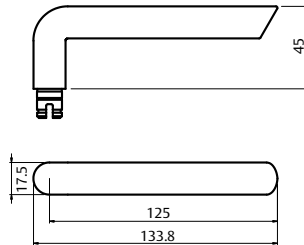

Lever 106

| | |
|-------------------------|--------|
| Length | 130mm |
| Projection | 48mm |
| Finger clearance | 28.4mm |

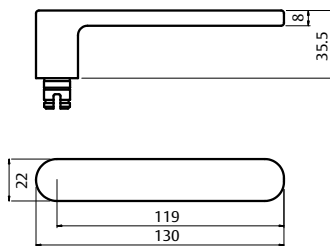

Lever 123

| | |
|-------------------------|---------|
| Length | 130.5mm |
| Projection | 59mm |
| Finger clearance | 28.4mm |

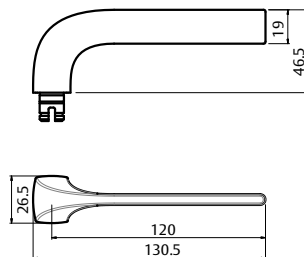

1220 Symphony Series Brass Door Handles

Non compliant lever/knob types

Lever 178

| | |
|-------------------------|--------|
| Length | 130mm |
| Projection | 63.6mm |
| Finger clearance | 28.4mm |

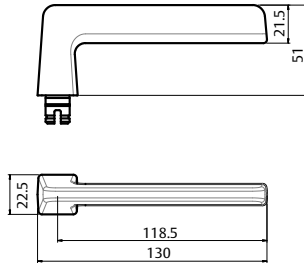

Lever 41

| | |
|-------------------------|--------|
| Length | 130mm |
| Projection | 61.5mm |
| Finger clearance | 40.5mm |

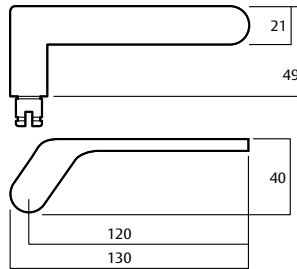

* Lever is an asymmetrical design and therefore must be handed.

Lever 97

| | |
|-------------------------|--------|
| Length | 120mm |
| Projection | 50.5mm |
| Finger clearance | 34.6mm |

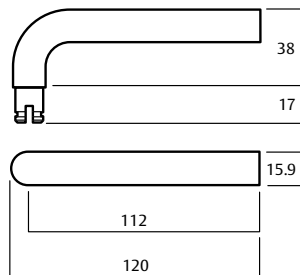

Knob 20

| | |
|-------------------|------|
| Diameter | 50mm |
| Projection | 73mm |

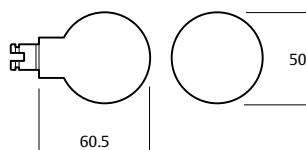

20 Knob can be used on outside rose only.

1220 Symphony Series Brass Door Handles

Handed Levers

Lever 122

| | |
|-------------------------|---------|
| Length | 130.5mm |
| Projection | 59mm |
| Finger clearance | 28.4mm |

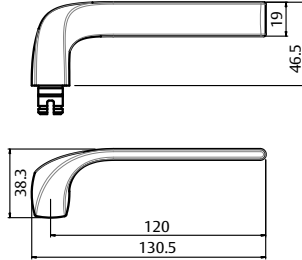

Lever 153

| | |
|-------------------------|--------|
| Length | 120mm |
| Projection | 70.6mm |
| Finger clearance | 28.4mm |

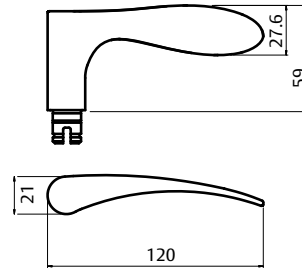

1220 Symphony Through Fix Escutcheon Kits

Through fix kits are optimised for use with Selector Series Mortise Locks. Supplied with two M4 64mm stainless screws for through fix installation.

Double Oval Cylinder Escutcheons Kit

Part Number 1226/6

Escutcheons supplied

Outside: Oval Cylinder Escutcheon

Inside: Oval Cylinder Escutcheon

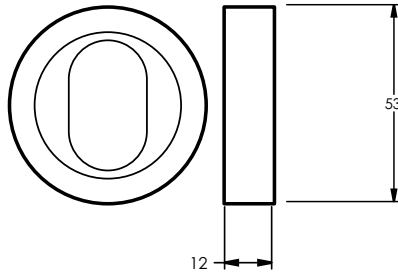

Outside

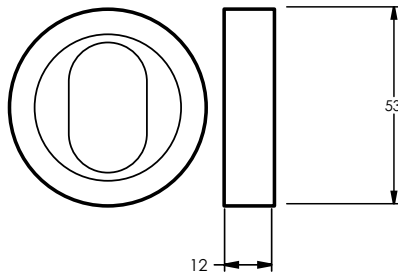

Inside

Oval Cylinder and Turnknob Escutcheons Kit

Part Number 1226/7N

Escutcheons supplied

Outside: Oval Cylinder Escutcheon

Inside: Turnknob Escutcheon

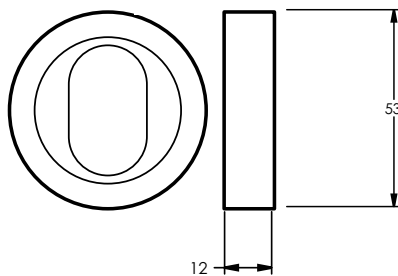

Outside

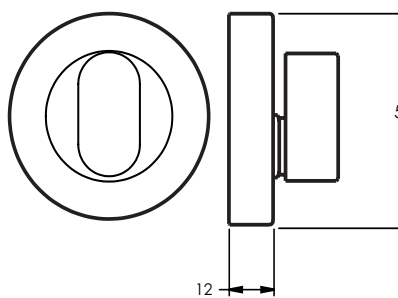

Inside

1220 Symphony Through Fix Escutcheon Kits

Privacy Indicating Emergency Turn and Disabled Accessible Turnknob Escutcheons Kit

Part Number 1228/9P

Escutcheons supplied

Outside: Privacy Indicating Emergency Turn Escutcheon

Inside: Privacy Indicating Disabled Accessible Turnknob Escutcheon

Note: Kits with Disabled Accessible Turnknobs require handing.

Handing is based on the door, same as handing of a full set of rose door lever handles.

A left-handed escutcheon kit suits a left-handed door and will be supplied with a right-handed disabled accessible turnknob, as this turnknob is intended to be used on the interior side of the door.

Door thickness: Suitable for 32 - 45mm doors. Extended tail bars available for thicker doors.

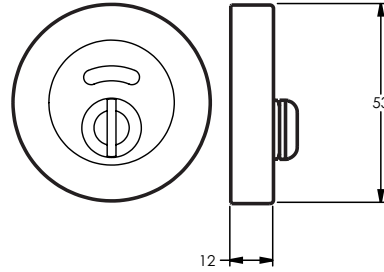

Outside

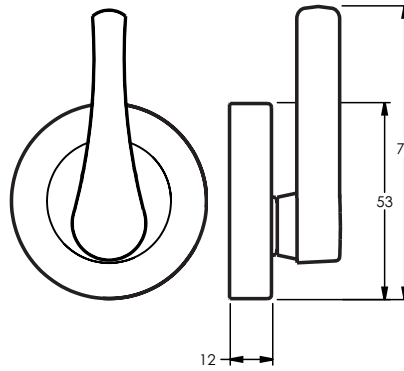

Inside

HAND OF DOOR ACCORDING TO ENGLISH PRACTICE

| DOOR OPENING IN | DOOR OPENING OUT |
|---|---|
| <p>INSIDE</p> <p>RIGHT HAND KIT LEFT HAND KIT</p> <p>OUTSIDE</p> | <p>INSIDE</p> <p>RIGHT HAND KIT LEFT HAND KIT</p> <p>OUTSIDE</p> |

Note: Common kit configurations are shown, for other kit variations please refer to the ordering procedure at the end of this section.

1220 Symphony Cylinder & Turn Escutcheons

Surface mounted escutcheons are optimised for use with Synergy Series Mortice Locks.

Oval Cylinder Escutcheon

Part Number 1226/I

Supplied with

2x Short & 2x Medium Wood Screws (SP1226-219)

(Replaces 1226)

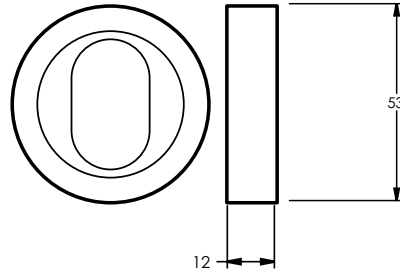

Turnknob Escutcheon

Part Number 1227/IN

Supplied with

2 x Short & 2 x Medium Wood Screws (SP1226-219)

1 x Short, Medium & Long Tail Bars and Spring (SP1227-219)

1 x Flat Tail Bar & Split Pin (SP12227-319)

1 x Instructions (1220-321)

(Replaces 1227)

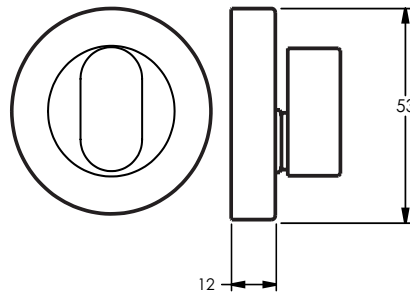

Privacy Indicating Turnknob Escutcheon

Part Number 1227/IP

Supplied with

2 x Short & 2 x Medium Wood Screws (SP1226-219)

1 x Short, Medium & Long Tail Bars and Spring (SP1227-219)

1 x Flat Tail Bar & Split Pin (SP12227-319)

1 x Instructions (1220-321)

(Replaces 1227P)

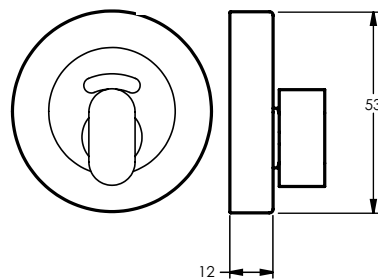

Emergency Turn Escutcheon

Part Number 1228/IN

Supplied with

2 x Short & 2 x Medium Wood Screws (SP1226-219)

1 x Emergency Tail Bar (SP1227-119)

(Replaces 1228)

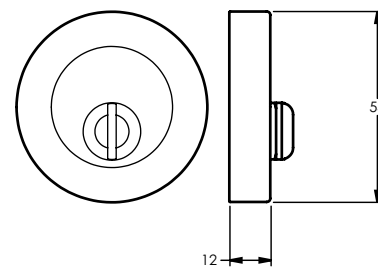

1220 Symphony Cylinder & Turn Escutcheons

Privacy Indicating Emergency Turn Escutcheon

Part Number 1228/IP

Supplied with

2 x Short & 2 x Medium Wood Screws (SP1226-219)
1 x Emergency Tail Bar (SP1227-119)

(Replaces 1228P)

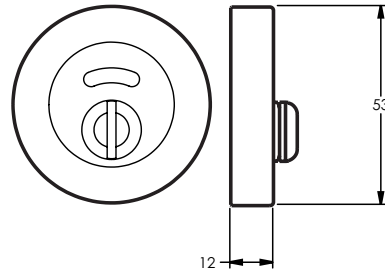

Disabled Accessible Turnknob

Part Number 1229/IN

Supplied with

2 x Short & 2 x Medium Wood Screws (SP1226-219)
1 x Short, Medium & Long Tail Bars and Spring (SP1227-219)
1 x Instructions (1220-321)

(Replaces 1227DT)

Note: Disabled Accessible Turns require handing.

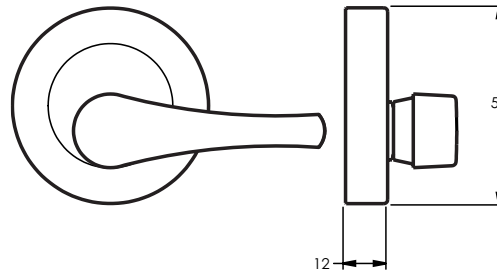

Disabled Accessible Privacy Indicating Turnknob

Part Number 1229/IP

Supplied with

2 x Short & 2 x Medium Wood Screws (SP1226-219)
1 x Short, Medium & Long Tail Bars and Spring (SP1227-219)
1 x Instructions (1220-321)

Note: Disabled Accessible Turns require handing.

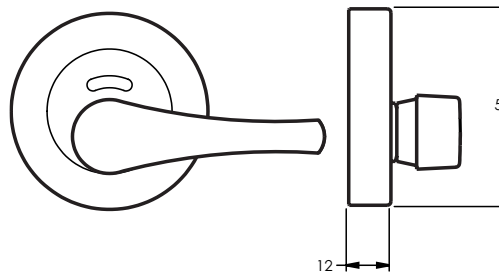

Door thickness: Suitable for 32 - 45mm doors.
Extended tail bars available for thicker doors.

1220 Symphony Privacy Adaptor

Privacy Adaptor

Part Number 3890

Dimensions 52mm x 11.6mm

Supplied with

2 x M4 x 77mm Stainless Steel Screws (SP0655MBK)
1 x Spindle 7.6mm x 90mm
1 x Instructions (3890-121)

Finishes

Satin Chrome (SC)
Chrome Plate (CP)
Powder Coat (PC)
Not available in
brass finishes

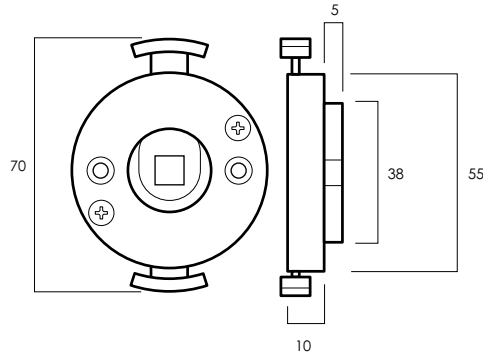

The 3890 Privacy Adaptor has a patented built in clutching mechanism which allows the engaged mode to be overridden by use of specified force applied in a single downward action on the lever. This will allow entry in an emergency situation without the use of any type of tool.

The privacy adaptor can be installed onto any existing Lockwood lever set and standard 5260 Tubular Latch.

1220 Symphony Series Ordering Procedure

Sample part number 1220/1221/41LCP is made up of several sections. Choose your product by selecting an option from each section.

Half Set

Note: Choose one rose only, exterior or interior.

| | | | |
|---------------|-------------|---------|--------|
| Exterior Rose | Lever/ Knob | Handing | Finish |
| 1220 | 41 | L | CP |

Full Set

| | | | | |
|---------------|---------------|-------------|---------|--------|
| Exterior Rose | Interior Rose | Lever/ Knob | Handing | Finish |
| 1220 | 1221 | 41 | L | CP |

| Exterior Rose Type | |
|---------------------|------|
| Exterior Rose | 1220 |
| Exterior Blank Rose | 1222 |
| Exterior Fixed Rose | 1224 |

| Interior Rose Type | |
|---|------|
| Interior Rose | 1221 |
| Interior Blank Rose | 1223 |
| Interior Fixed Rose | 1225 |
| Interior Rose to suit 3890 Privacy Adaptor <small>*Only available in SC, CP and PC</small> | 1321 |

AS1428.1 Compliant Lever Types

| | | |
|-----|-----|-----|
| 102 | 111 | 112 |
| 115 | 116 | 118 |
| 124 | 131 | 132 |
| 133 | 142 | 144 |
| 145 | 155 | 166 |
| 47 | 59 | 70 |
| 74 | 76 | 77 |
| 90 | | |

Non compliant lever/knob types

| | | |
|-----|-----|-----|
| 101 | 104 | 123 |
| 178 | 41 | 97 |
| 20 | | |

Handed Levers

| | |
|-----|-----|
| 122 | 153 |
|-----|-----|

| Handing | |
|------------------------|---|
| Right Handed | R |
| Left Handed | L |
| NB: Omit if non-handed | |

| Finish | |
|----------------------|----|
| Satin Chrome Brushed | SC |
| Chrome Plate | CP |
| Polished Brass | PB |
| Polyester Powdercoat | PC |

Special Finishes

| | |
|----------------------------------|-----|
| Polished Brass Unlacquered | BU |
| Satin Brass | SB |
| Satin Brass Unlacquered | SBU |
| Architectural Bronze | AZ |
| Architectural Bronze Unlacquered | AU |
| Antique Copper | AC |
| Oil Rubbed Bronze | ORB |

Note: Refer to the decorative finishes section at the end of this catalogue for images of the full metal finishes and powder coat colour range available.

1220 Symphony Series Ordering Procedure

Selector Series Escutcheon Kits

Through fix kits are optimised for use with Selector Series Mortice Locks. Supplied with two M4 64mm stainless screws for through fix installation.

Sample part number 1226/9NLSC is made up of several sections. The description of this part number is a left-handed oval cylinder and disabled accessible turnknob escutcheon kit.

| | | | | |
|-------------------|-------------------|-------------------|---------|--------|
| Exterior Function | Interior Function | Privacy Indicator | Handing | Finish |
| 1226 | 9 | N | L | SC |

| Exterior Function | |
|-------------------|------|
| Oval Cylinder | 1226 |
| Emergency Turn | 1228 |

Notes:
Order 1226/I if only one oval cylinder escutcheon is required. Wood screws will be supplied for surface mounting.

1228/6 Kit is not applicable.

| Interior Function | |
|------------------------------|---|
| Oval Cylinder | 6 |
| Oval Turnknob | 7 |
| Disabled Accessible Turnknob | 9 |

| Privacy Indicator | |
|--------------------|---|
| Oval Cylinder | - |
| Non Indicating | N |
| Privacy Indicating | P |

Note:
Privacy indicator applies for both exterior and interior functions.

| Handing | |
|--------------|---|
| Right Handed | R |
| Left Handed | L |

Note:
Handing is based on the door, same as handing of a full set of rose door lever handles.

The sample part number shown above suits a left-handed door. This kit will be supplied with a right-handed disabled accessible turnknob, as the turnknob is intended to be used on the interior side of the door.

Only Kits with Disabled Accessible Turnknobs require handing.

| Finish | |
|----------------------|----|
| Satin Chrome Brushed | SC |
| Chrome Plate | CP |
| Polished Brass | PB |
| Polyester Powdercoat | PC |

| Special Finishes | |
|----------------------------------|-----|
| Polished Brass Unlacquered | BU |
| Satin Brass | SB |
| Satin Brass Unlacquered | SBU |
| Architectural Bronze | AZ |
| Architectural Bronze Unlacquered | AU |
| Antique Copper | AC |
| Oil Rubbed Bronze | ORB |

Note: Refer to the decorative finishes section at the end of this catalogue for images of the full metal finishes and powder coat colour range available.

1220 Symphony Series Ordering Procedure

Synergy Series Escutcheons

Surface mounted escutcheons are optimised for use with Synergy Series Mortice Locks.

Supplied with wood screws to suit surface mounting on either side of the door.

| | | | | |
|-----------------|--------|-------------------|---------|--------|
| Escutcheon Type | Fixing | Privacy Indicator | Handing | Finish |
| 1229 | I | P | L | SC |

| Escutcheon Type | |
|------------------------------|-------|
| Oval Cylinder | 1226 |
| Oval Turnknob | 1227 |
| Emergency Turn | 1228 |
| Disabled Accessible Turnknob | 1229* |

Note:

*Cannot be used with Selector Mortice Locks, please order escutcheon kits if needed.

| Fixing |
|----------------|
| Wood Screw |
| Surface Fixing |

| Privacy Indicator | |
|--------------------|---|
| Oval Cylinder | - |
| Non Indicating | N |
| Privacy Indicating | P |

| Handing | |
|------------|---|
| Left Hand | L |
| Right Hand | R |

NB: Only Disabled Accessible Turnknobs require handing

| Finish | |
|----------------------|----|
| Satin Chrome Brushed | SC |
| Chrome Plate | CP |
| Polished Brass | PB |
| Polyester Powdercoat | PC |

| Special Finishes | |
|----------------------------------|-----|
| Polished Brass Unlacquered | BU |
| Satin Brass | SB |
| Satin Brass Unlacquered | SBU |
| Architectural Bronze | AZ |
| Architectural Bronze Unlacquered | AU |
| Antique Copper | AC |
| Oil Rubbed Bronze | ORB |

Note: Refer to the decorative finishes section at the end of this catalogue for images of the full metal finishes and powder coat colour range available.

1420 Symphony Series Square Rose Door Handles



Lockwood Symphony Series door furniture is manufactured from high quality solid brass material. The comprehensive lever range matched with concealed screw fixings by way of threaded rose trims, provides a stylish look for the most elegant interiors.

The accessory range includes cylinder escutcheons, emergency turnknobs and disabled accessible turnknobs. For installers, the unique turn mechanism adjusts to suit the thickness of the door and removes the need to cut tailbars to length.

A full range of finishes from satin chrome through to a range of brass finishes and polyester powder coat provides all the options for matching to interior designs.

Proudly Australian Made at our factory in Oakleigh to the highest quality standards for strength, durability and corrosion resistance.

Product Details

| | |
|----------------------------|--|
| Dimensions | 58mm x 58mm x 11.6mm. |
| Handing | A removable stop screw allows all symmetrically designed levers (e.g. Cadenza) to be handed on site. Levers of asymmetrical design (e.g. Veloce) cannot be reversed. Specify left or right handed when ordering. |
| Materials | All Lockwood roses and levers contained in the 1420 series are of solid brass construction. |
| Fixing | Fully concealed on both sides. |
| Door Thickness | Selector 3770 and Synergy 3570 Series: 32mm to 50mm Lockwood 5260 Latches: 33mm to 50mm |
| Decorative Finishes | <p>Standard Finish: Satin Chrome Brushed (SC)</p> <p>Non-Standard Finish: Chrome Plate (CP) Polished Brass (PB) Polyester Powdercoat (PC)</p> <p>Special Finish: Architectural Bronze (AZ) Architectural Bronze Unlacquered (AU) Antique Copper (AC) Polished Brass Unlacquered (BU) Satin Brass (SB) Oil Rubbed Bronze (ORB) Satin Brass Unlacquered (SBU)</p> |
| Privacy | Privacy function for Symphony Square Rose Furniture is achieved using the 3690 privacy adaptor and standard Symphony 1421 interior rose. |

Standards and Compliance



1420 Series has been successfully tested up to 4 hours with a fire rated Lockwood mortice lock on fire door assemblies (depending on type of doorset) in accordance with Australian Standard AS1905.1:2005, Fire Resistant Doorsets.

D8

1420 Series lever sets have been successfully tested to conform with Level D8 (500,000 cycles) under Australian Standard AS4145.2-2008, Locksets and hardware for doors and windows.



1420 Series lever sets in satin chrome finish has been successfully tested to AS 4145.2 2008 for Neutral Salt Spray – With SC Finish passing C10 1000 Hours - Extreme Corrosion Resistance. Suitable for coastal applications.



1420 Series includes levers and turns (as shown) that meet the requirements of AS1428.1-2009, Design for access and mobility.

Lockwood Brass Door Furniture is designed, assembled and customised in Australia to suit the requirements of the Australian Market.

1420 Symphony Series Square Rose Door Handles

BRASS CORE

The Symphony Series square rose furniture features a 58mm solid brass rose with horizontal screw fixings, concealed on both sides by a grub screw fixed, square rose trim.

Supplied with:

2 x M4 x 65mm Stainless Steel Screws (SP1220-119)
1 x Instructions (1220-221)

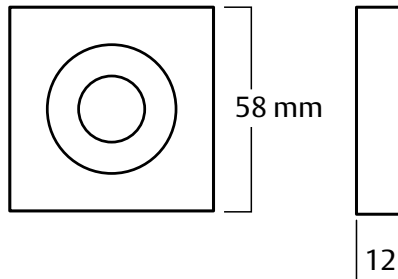

AS1428.1 Compliant Levers

| Lever 102 | |
|-------------------------|---------|
| Length | 134.3mm |
| Projection | 57.5mm |
| Finger clearance | 28.4mm |

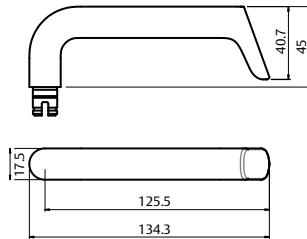

| Lever 111 | |
|-------------------------|--------|
| Length | 130mm |
| Projection | 48.5mm |
| Finger clearance | 28.4mm |

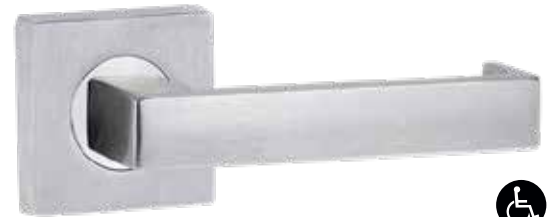
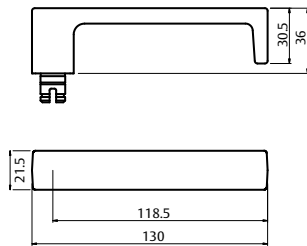

| Lever 112 | |
|-------------------------|---------|
| Length | 130.5mm |
| Projection | 48mm |
| Finger clearance | 28.4mm |

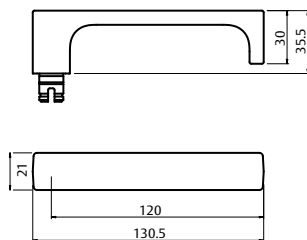

1420 Symphony Series Square Rose Door Handles

AS1428.1 Compliant Levers

Lever 115

| | |
|-------------------------|---------|
| Length | 140.4mm |
| Projection | 60mm |
| Finger clearance | 28.4mm |

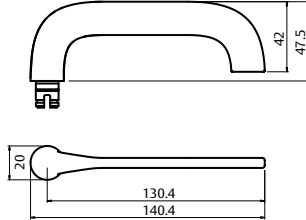

Lever 116

| | |
|-------------------------|---------|
| Length | 140.5mm |
| Projection | 47.6mm |
| Finger clearance | 28.4mm |

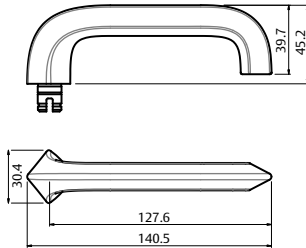

Lever 118

| | |
|-------------------------|--------|
| Length | 128mm |
| Projection | 58mm |
| Finger clearance | 28.4mm |

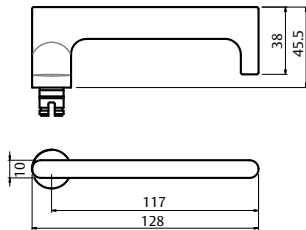

Lever 124

| | |
|-------------------------|---------|
| Length | 130.5mm |
| Projection | 59mm |
| Finger clearance | 28.4mm |

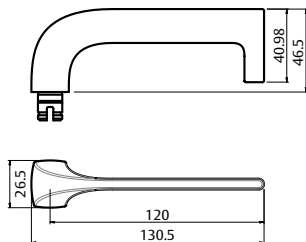

1420 Symphony Series Square Rose Door Handles

AS1428.1 Compliant Levers

Lever 131

| | |
|-------------------------|---------|
| Length | 134.5mm |
| Projection | 53mm |
| Finger clearance | 28.4mm |

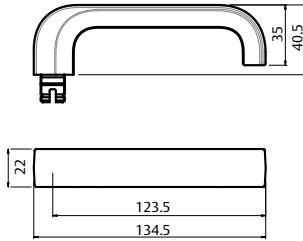

Lever 132

| | |
|-------------------------|--------|
| Length | 130mm |
| Projection | 57.5mm |
| Finger clearance | 28.4mm |

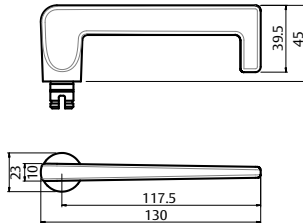

Lever 133

| | |
|-------------------------|--------|
| Length | 130mm |
| Projection | 53.5mm |
| Finger clearance | 28.4mm |

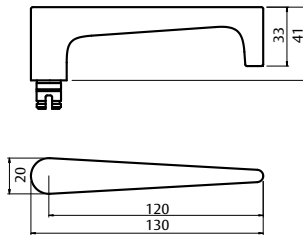

Lever 142

| | |
|-------------------------|---------|
| Length | 130.5mm |
| Projection | 55mm |
| Finger clearance | 28.4mm |

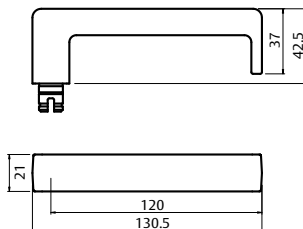

1420 Symphony Series Square Rose Door Handles

AS1428.1 Compliant Levers

Lever 144

| | |
|-------------------------|---------|
| Length | 128.8mm |
| Projection | 57.5mm |
| Finger clearance | 28.4mm |

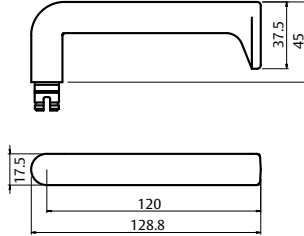

Lever 145

| | |
|-------------------------|--------|
| Length | 130mm |
| Projection | 58.5mm |
| Finger clearance | 28.4mm |

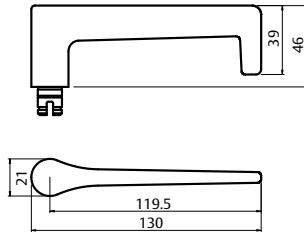

Lever 155

| | |
|-------------------------|---------|
| Length | 129.3mm |
| Projection | 57.5mm |
| Finger clearance | 28.4mm |

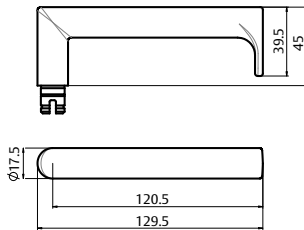

Lever 166

| | |
|-------------------------|--------|
| Length | 130mm |
| Projection | 48mm |
| Finger clearance | 28.4mm |

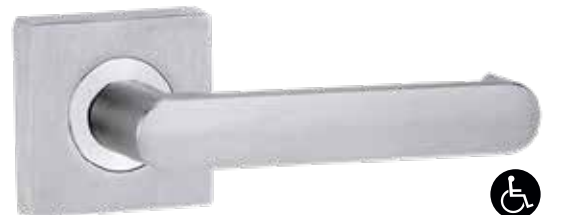
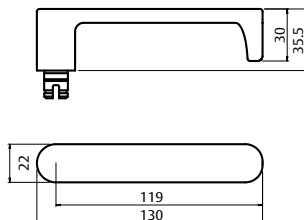

1420 Symphony Series Square Rose Door Handles

AS1428.1 Compliant Levers

Lever 180

| | |
|-------------------------|---------|
| Length | 123.5mm |
| Projection | 53.1mm |
| Finger clearance | 28.4mm |

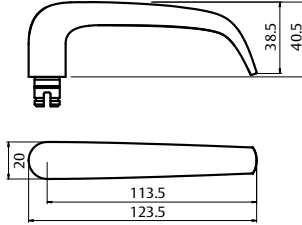

Lever 47

| | |
|-------------------------|--------|
| Length | 120mm |
| Projection | 49.6mm |
| Finger clearance | 40mm |

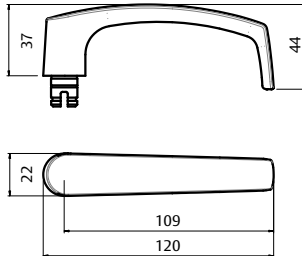

Lever 59

| | |
|-------------------------|--------|
| Length | 121mm |
| Projection | 57.5mm |
| Finger clearance | 38mm |

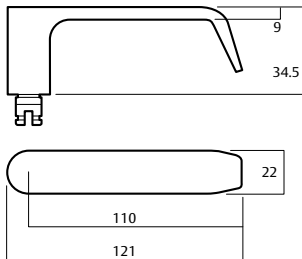

Lever 70

| | |
|-------------------------|-------|
| Length | 121mm |
| Projection | 53mm |
| Finger clearance | 37mm |

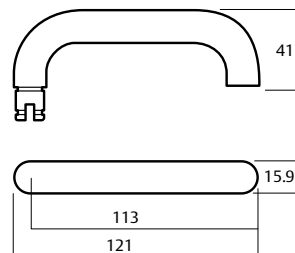

1420 Symphony Series Square Rose Door Handles

AS1428.1 Compliant Levers

Lever 74

| | |
|-------------------------|-------|
| Length | 120mm |
| Projection | 53mm |
| Finger clearance | 45mm |

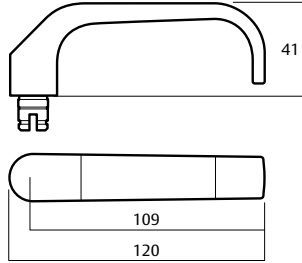

Lever 76

| | |
|-------------------------|--------|
| Length | 125mm |
| Projection | 48.5mm |
| Finger clearance | 28.4mm |

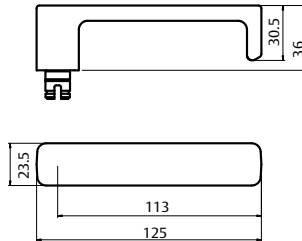

Lever 77

| | |
|-------------------------|--------|
| Length | 121mm |
| Projection | 51mm |
| Finger clearance | 40.5mm |

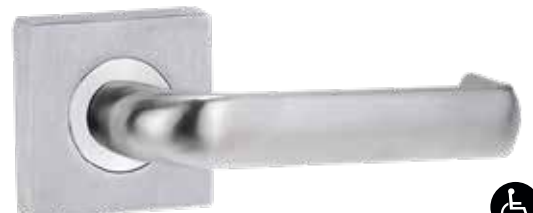
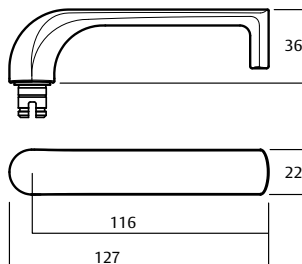

Lever 90

| | |
|-------------------------|---------|
| Length | 118.5mm |
| Projection | 52mm |
| Finger clearance | 45mm |

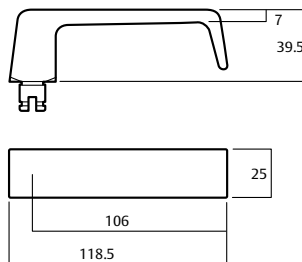

1420 Symphony Series Square Rose Door Handles

Non compliant lever/knob types

Lever 101

| | |
|-------------------------|--------|
| Length | 130mm |
| Projection | 48.5mm |
| Finger clearance | 28.4mm |

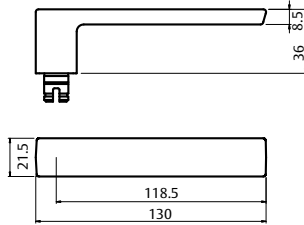

Lever 104

| | |
|-------------------------|---------|
| Length | 133.8mm |
| Projection | 57.5mm |
| Finger clearance | 28.4mm |

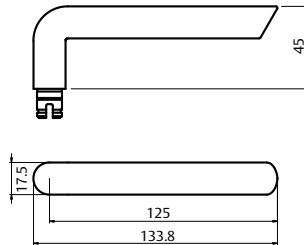

Lever 106

| | |
|-------------------------|--------|
| Length | 130mm |
| Projection | 48mm |
| Finger clearance | 28.4mm |

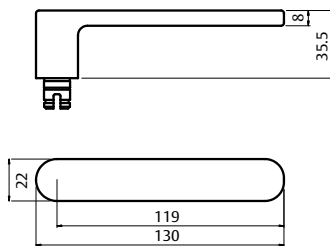

Lever 123

| | |
|-------------------------|---------|
| Length | 130.5mm |
| Projection | 59mm |
| Finger clearance | 28.4mm |

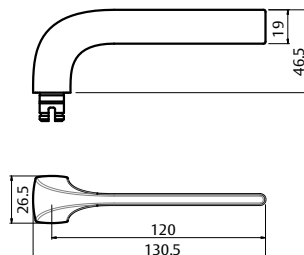

1420 Symphony Series Square Rose Door Handles

Non compliant lever/knob types

Lever 178

| | |
|-------------------------|--------|
| Length | 130mm |
| Projection | 63.6mm |
| Finger clearance | 28.4mm |

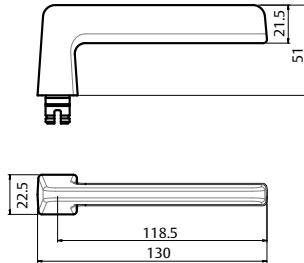

Lever 41

| | |
|-------------------------|--------|
| Length | 130mm |
| Projection | 61.5mm |
| Finger clearance | 40.5mm |

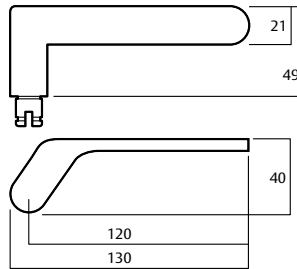

* Lever is an asymmetrical design and therefore must be handed.

Lever 97

| | |
|-------------------------|--------|
| Length | 120mm |
| Projection | 50.5mm |
| Finger clearance | 34.6mm |

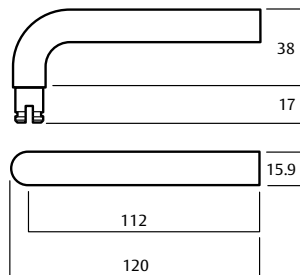

Knob 20

| | |
|-------------------|------|
| Diameter | 50mm |
| Projection | 73mm |

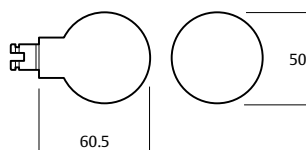

20 Knob can be used on outside rose only.

1420 Symphony Series Square Rose Door Handles

Handed Levers

Lever 122

| | |
|-------------------------|---------|
| Length | 130.5mm |
| Projection | 59mm |
| Finger clearance | 28.4mm |

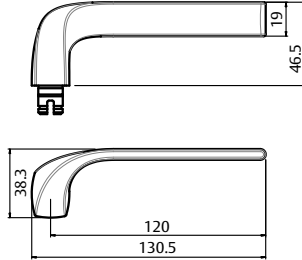

Lever 153

| | |
|-------------------------|--------|
| Length | 120mm |
| Projection | 70.6mm |
| Finger clearance | 28.4mm |

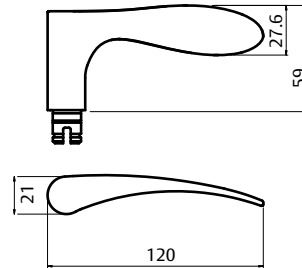

1420 Symphony Through Fix Escutcheon Kits

Through fix kits are optimised for use with Selector Series Mortice Locks. Supplied with two M4 64mm stainless screws for through fix installation.

Double Oval Cylinder Escutcheons Kit

Part Number 1426/6

Escutcheons supplied

Outside: Oval Cylinder Escutcheon

Inside: Oval Cylinder Escutcheon

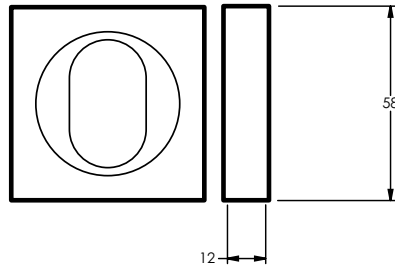

Outside

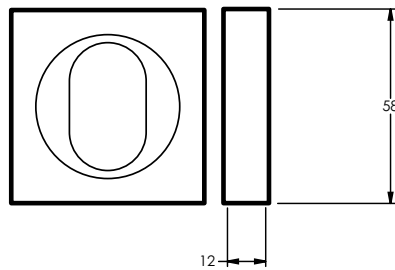

Inside

Oval Cylinder and Turnknob Escutcheons Kit

Part Number 1426/7N

Escutcheons supplied

Outside: Oval Cylinder Escutcheon

Inside: Turnknob Escutcheon

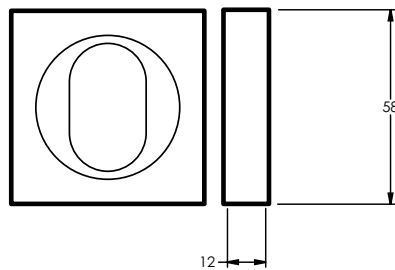

Outside

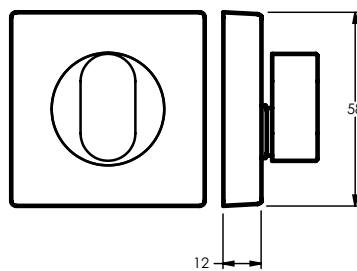

Inside

1420 Symphony Through Fix Escutcheon Kits

Privacy Indicating Emergency Turn and Disabled Accessible Turnknob Escutcheons Kit

Part Number 1428/9P

Escutcheons supplied

Outside: Privacy Indicating Emergency Turn Escutcheon

Inside: Privacy Indicating Disabled Accessible Turnknob Escutcheon

Note: Kits with Disabled Accessible Turnknobs require handing.

Handing is based on the door, same as handing of a full set of rose door lever handles.

A left-handed escutcheon kit suits a left-handed door and will be supplied with a right-handed disabled accessible turnknob, as this turnknob is intended to be used on the interior side of the door.

Door thickness: Suitable for 32 - 45mm doors. Extended tail bars available for thicker doors.

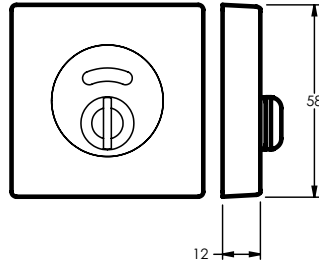

Outside

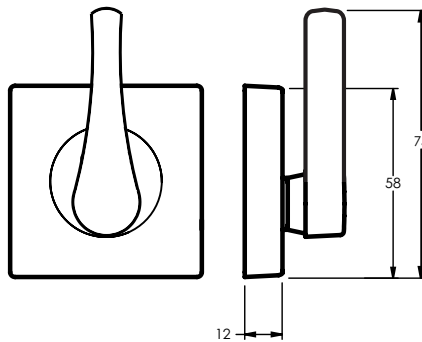

Inside

HAND OF DOOR ACCORDING TO ENGLISH PRACTICE

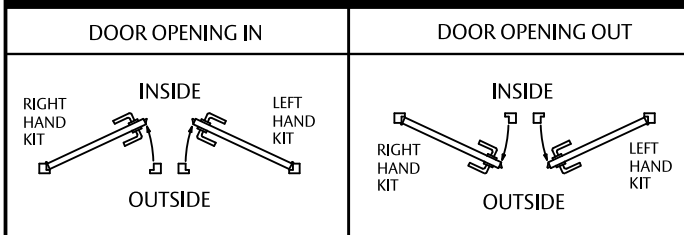

Note: Common kit configurations are shown, for other kit variations please refer to the ordering procedure at the end of this section.

1420 Symphony Cylinder & Turn Escutcheons

Surface mounted escutcheons are optimised for use with Synergy Series Mortice Locks.

Oval Cylinder Escutcheon

Part Number 1426/I

Supplied with

2 x Short & 2 x Medium Wood Screws (SP1226-219)

(Replaces 1426)

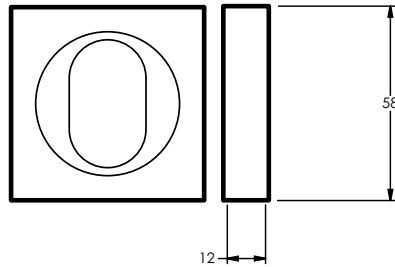

Turnknob Escutcheon

Part Number 1427/IN

Supplied with

2 x Short & 2 x Medium Wood Screws (SP1226-219)

1 x Short, Medium & Long Tail Bars and Spring (SP1227-219)

1 x Flat Tail Bar & Split Pin (SP12227-319)

1 x Instructions (1220-321)

(Replaces 1427)

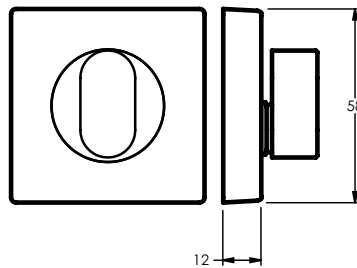

Privacy Indicating Turnknob Escutcheon

Part Number 1427/IP

Supplied with

2 x Short & 2 x Medium Wood Screws (SP1226-219)

1 x Short, Medium & Long Tail Bars and Spring (SP1227-219)

1 x Flat Tail Bar & Split Pin (SP12227-319)

1 x Instructions (1220-321)

(Replaces 1427P)

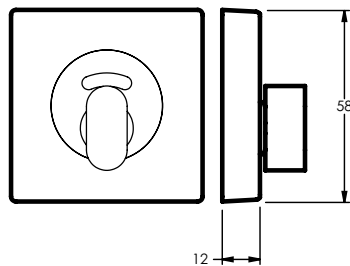

Emergency Turn Escutcheon

Part Number 1428/IN

Supplied with

2 x Short & 2 x Medium Wood Screws (SP1226-219)

1 x Emergency Tail Bar (SP1227-119)

(Replaces 1428P)

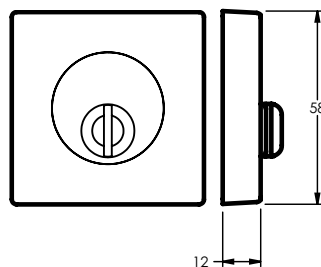

1420 Symphony Cylinder & Turn Escutcheons

Privacy Indicating Emergency Turn Escutcheon

Part Number 1428/IP

Supplied with

2 x Short & 2 x Medium Wood Screws (SP1226-219)
1 x Emergency Tail Bar (SP1227-119)

(Replaces 1428P)

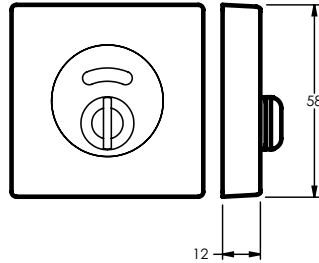

Disabled Accessible Turnknob

Part Number 1429/IN

Supplied with

2 x Short & 2 x Medium Wood Screws (SP1226-219)
1 x Short, Medium & Long Tail Bars and Spring (SP1227-219)
1 x Flat Tail Bar & Split Pin (SP12227-319)
1 x Instructions (1220-321)

(Replaces 1427DT)

Note: Disabled Accessible Turnknob require handing.

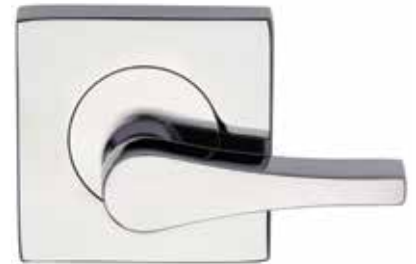
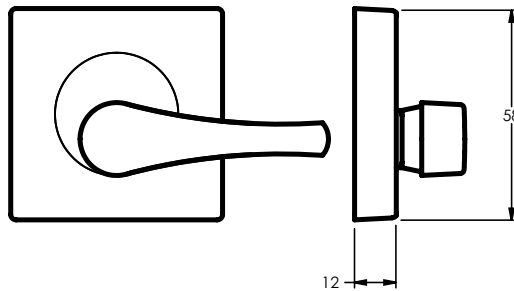

Disabled Accessible Privacy Indicating Turnknob

Part Number 1429/IP

Supplied with

2 x Short & 2 x Medium Wood Screws (SP1226-219)
1 x Short, Medium & Long Tail Bars and Spring (SP1227-219)
1 x Flat Tail Bar & Split Pin (SP12227-319)
1 x Instructions (1220-321)

Note: Disabled Accessible Turnknob require handing.

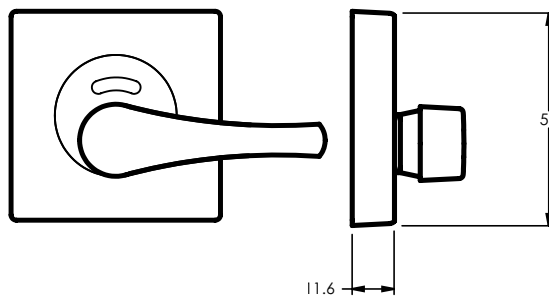

Door thickness: Suitable for 32 - 45mm doors.
Extended tail bars available for thicker doors.

1420 Symphony Privacy Adaptor

Privacy Adaptor 3690

Part Number 3690

Dimensions 58mm x 11.6mm

Supplied with

2 x M4 x 77mm Stainless Steel Screws (SP0655MBK)
1 x Spindle 7.6mm x 90mm
1 x Instructions (3890-121)

Finishes

Satin Chrome (SC)
Chrome Plate (CP)
Powder Coat (PC)
Not available in
brass finishes

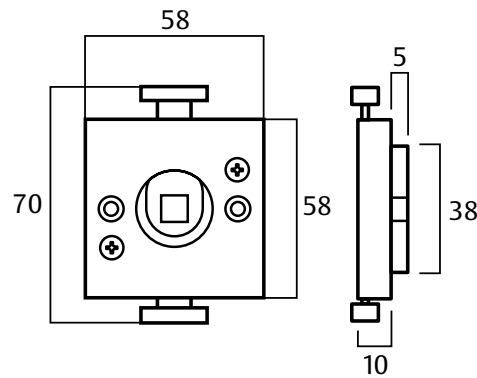

The 3690 Privacy Adaptor has a patented built in clutching mechanism which allows the engaged mode to be overridden by use of specified force applied in a single downward action on the lever. This will allow entry in an emergency situation without the use of any type of tool.

The privacy adaptor can be installed onto any existing Lockwood lever set and standard 5260 Tubular Latch.

1420 Symphony Series Ordering Procedure

Ordering Procedure

Sample part number 1420/1421/41LCP is made up of several sections. Choose your product by selecting an option from each section.

Half Set

Note: Choose one rose only, exterior or interior.

| | | | |
|---------------|-------------|---------|--------|
| Exterior Rose | Lever/ Knob | Handing | Finish |
| 1420 | 41 | L | CP |

Full Set

| | | | | |
|---------------|---------------|-------------|---------|--------|
| Exterior Rose | Interior Rose | Lever/ Knob | Handing | Finish |
| 1420 | 1421 | 41 | L | CP |

| Exterior Rose Type | |
|---------------------|------|
| Exterior Rose | 1420 |
| Exterior Blank Rose | 1422 |
| Exterior Fixed Rose | 1424 |

| Interior Rose Type | |
|---------------------|------|
| Interior Rose | 1421 |
| Interior Blank Rose | 1423 |
| Interior Fixed Rose | 1425 |

| AS1428.1 Compliant Lever Types | | |
|--------------------------------|-----|-----|
| 102 | 111 | 112 |
| 115 | 116 | 118 |
| 124 | 131 | 132 |
| 133 | 142 | 144 |
| 145 | 155 | 166 |
| 47 | 59 | 70 |
| 74 | 76 | 77 |
| 90 | | |

| Non compliant lever/knob types | | |
|--------------------------------|-----|-----|
| 101 | 104 | 123 |
| 178 | 41 | 97 |
| 20 | | |

| Handed Levers | |
|---------------|-----|
| 122 | 153 |

| Handing | |
|------------------------|---|
| Right Handed | R |
| Left Handed | L |
| NB: Omit if non-handed | |

| Finish | |
|----------------------|----|
| Satin Chrome Brushed | SC |
| Chrome Plate | CP |
| Polished Brass | PB |
| Polyester Powdercoat | PC |

| Special Finishes | |
|----------------------------------|-----|
| Polished Brass Unlacquered | BU |
| Satin Brass | SB |
| Satin Brass Unlacquered | SBU |
| Architectural Bronze | AZ |
| Architectural Bronze Unlacquered | AU |
| Antique Copper | AC |
| Oil Rubbed Bronze | ORB |

Note: Refer to the decorative finishes section at the end of this catalogue for images of the full metal finishes and powder coat colour range available.

1420 Symphony Series Ordering Procedure

Selector Series Escutcheon Kits

Through fix kits are optimised for use with Selector Series Mortice Locks. Supplied with two M4 64mm stainless screws for through fix installation.

Sample part number 1426/9NLSC is made up of several sections. The description of this part number is a left-handed oval cylinder and disabled accessible turnknob escutcheon kit.

| | | | | |
|-------------------|-------------------|-------------------|---------|--------|
| Exterior Function | Interior Function | Privacy Indicator | Handing | Finish |
| 1426 | 9 | N | L | SC |

| Exterior Function | |
|---|------|
| Oval Cylinder | 1426 |
| Emergency Turn | 1428 |
| Notes: Order 1426/I if only one oval cylinder escutcheon is required. Wood screws will be supplied for surface mounting. 1428/6 Kit is not applicable. | |

| Interior Function | |
|------------------------------|---|
| Oval Cylinder | 6 |
| Oval Turnknob | 7 |
| Disabled Accessible Turnknob | 9 |

| Privacy Indicator | |
|---|---|
| Oval Cylinder | - |
| Non Indicating | N |
| Privacy Indicating | P |
| Note: Privacy indicator applies for both exterior and interior functions. | |

| Handing | |
|---|---|
| Right Handed | R |
| Left Handed | L |
| Note: Handing is based on the door, same as handing of a full set of rose door lever handles. The sample part number shown above suits a left-handed door. This kit will be supplied with a right-handed disabled accessible turnknob, as the turnknob is intended to be used on the interior side of the door. Only Kits with Disabled Accessible Turnknobs require handing. | |

| Finish | |
|----------------------|----|
| Satin Chrome Brushed | SC |
| Chrome Plate | CP |
| Polished Brass | PB |
| Polyester Powdercoat | PC |

| Special Finishes | |
|----------------------------------|-----|
| Polished Brass Unlacquered | BU |
| Satin Brass | SB |
| Satin Brass Unlacquered | SBU |
| Architectural Bronze | AZ |
| Architectural Bronze Unlacquered | AU |
| Antique Copper | AC |
| Oil Rubbed Bronze | ORB |

Note: Refer to the decorative finishes section at the end of this catalogue for images of the full metal finishes and powder coat colour range available.

1420 Symphony Series Ordering Procedure

Synergy Series Escutcheons

Surface mounted escutcheons are optimised for use with Synergy Series Mortice Locks.

Supplied with wood screws to suit surface mounting on either side of the door.

| Escutcheon Type | Fixing | Privacy Indicator | Handing | Finish |
|-----------------|--------|-------------------|---------|--------|
| 1429 | I | P | L | SC |

| Escutcheon Type | Fixing | Privacy Indicator | Handing | Finish |
|------------------------------------|------------------|----------------------|--|-------------------------|
| Oval Cylinder 1426 | Wood Screw | Oval Cylinder - | Left Handed L | Satin Chrome Brushed SC |
| Oval Turnknob 1427 | Surface Fixing I | Non Indicating N | Right Hand R | Chrome Plate CP |
| Emergency Turn 1428 | | Privacy Indicating P | NB: Only Disabled Accessible Turnknobs require handing | |
| Disabled Accessible Turnknob 1429* | | | | |

| Special Finishes | |
|----------------------------------|-----|
| Polished Brass Unlacquered | BU |
| Satin Brass | SB |
| Satin Brass Unlacquered | SBU |
| Architectural Bronze | AZ |
| Architectural Bronze Unlacquered | AU |
| Antique Copper | AC |
| Oil Rubbed Bronze | ORB |

Note:
*Cannot be used with Selector Mortice Locks, please order escutcheon kits if needed.

Note: Refer to the decorative finishes section at the end of this catalogue for images of the full metal finishes and powder coat colour range available.

1360 Series Brass Door Handles



Lockwood 1360 Series door furniture is manufactured from high quality solid brass material. The comprehensive lever range matched with ease of installation and compatibility with a wide range of Mortice Locks defines simple and reliable.

The accessory range includes cylinder escutcheons, emergency turns and disabled accessible turnknobs. For installers, the unique turn mechanism adjusts to suit the thickness of the door and removes the need to cut tailbars to length.

A full range of finishes from satin chrome through to a range of brass finishes and polyester powder coat provides all the options for matching to interior designs.

Proudly Australian Made at our factory at Oakleigh to the highest quality standards for strength, durability and corrosion resistance.

Product Details

| | |
|----------------------------|--|
| Dimensions | 65.5mm diameter x 11.6mm. |
| Handing | A removable stop screw allows all symmetrically designed levers (e.g. Cadenza) to be handed on site. Levers of asymmetrical design (e.g. Veloce) cannot be reversed. Specify left or right handed when ordering. |
| Materials | All Lockwood roses and levers contained in the 1360 series are of solid brass construction. |
| Fixing | Roses are designed to fit back to back. If outside rose is specified with concealed fixing, then the inside rose must be visible fixed. Roses numbered 1360, 1362, and 1364 are concealed fixed, roses numbered 1361, 1363 and 1365 are visible fixed. |
| Door Thickness | Selector 3770 and Synergy 3770 Series: 32mm to 50mm Lockwood 5260 Latches: 33mm to 50mm |
| Decorative Finishes | <p>Standard Finish: Satin Chrome Brushed (SC)</p> <p>Non-Standard Finish: Chrome Plate (CP) Polished Brass (PB) Polyester Powdercoat (PC)</p> <p>Special Finish: Architectural Bronze (AZ) Architectural Bronze Unlacquered (AU) Antique Copper (AC) Polished Brass Unlacquered (BU) Satin Brass (SB) Oil Rubbed Bronze (ORB) Satin Brass Unlacquered (SBU)</p> |

Standards and Compliance



1360 Series has been successfully tested up to 4 hours with a fire rated Lockwood mortice lock on fire door assemblies (depending on type of doorset) in accordance with Australian Standard AS1905.1:2005, Fire Resistant Doorsets.

D8

1360 Series lever sets have been successfully tested to conform with Level D8 (500,000 cycles) under Australian Standard AS4145.2-2008, Locksets and hardware for doors and windows.



1360 Series lever sets in satin chrome finish has been successfully tested to AS 4145.2 2008 for Neutral Salt Spray – With SC Finish passing C10 1000 Hours - Extreme Corrosion Resistance. Suitable for coastal applications.



1360 Series includes levers and turns (as shown) that meet the requirements of AS1428.1-2009, Design for access and mobility.

Lockwood Brass Door Furniture is designed, assembled and customised in Australia to suit the requirements of the Australian Market.

1360 Series Brass Door Handles

BRASS CORE

The 1360 Series rose furniture features a 65mm solid brass rose with diagonal screw fixings, concealed on the outside and visible on the inside.

Supplied with:

2 x M4 x 65mm Stainless Steel Screws (SP1220-119)
1 x Instructions (1220-221)

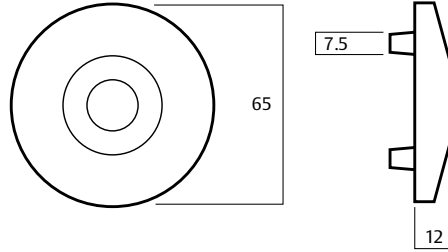

AS1428.1 Compliant Levers

Lever 102

| | |
|-------------------------|---------|
| Length | 134.3mm |
| Projection | 57.5mm |
| Finger clearance | 28.4mm |

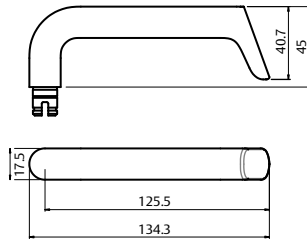

Lever 111

| | |
|-------------------------|--------|
| Length | 130mm |
| Projection | 48.5mm |
| Finger clearance | 28.4mm |

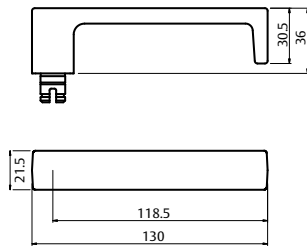

Lever 112

| | |
|-------------------------|---------|
| Length | 130.5mm |
| Projection | 48mm |
| Finger clearance | 28.4mm |

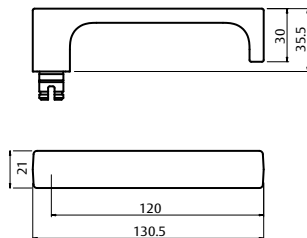

1360 Series Brass Door Handles

AS1428.1 Compliant Levers

Lever 115

| | |
|-------------------------|---------|
| Length | 140.4mm |
| Projection | 60mm |
| Finger clearance | 28.4mm |

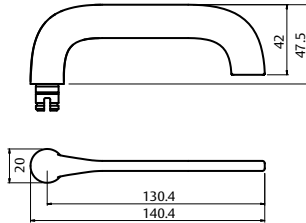

Lever 116

| | |
|-------------------------|---------|
| Length | 140.5mm |
| Projection | 47.6mm |
| Finger clearance | 28.4mm |

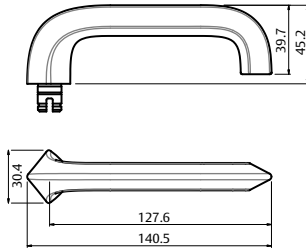

Lever 118

| | |
|-------------------------|--------|
| Length | 128mm |
| Projection | 58mm |
| Finger clearance | 28.4mm |

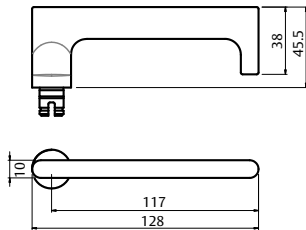

Lever 124

| | |
|-------------------------|---------|
| Length | 130.5mm |
| Projection | 59mm |
| Finger clearance | 28.4mm |

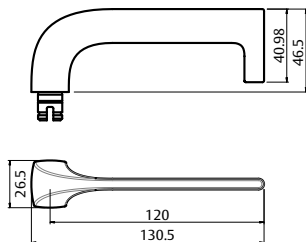

1360 Series Brass Door Handles

AS1428.1 Compliant Levers

Lever 131

| | |
|-------------------------|---------|
| Length | 134.5mm |
| Projection | 53mm |
| Finger clearance | 28.4mm |

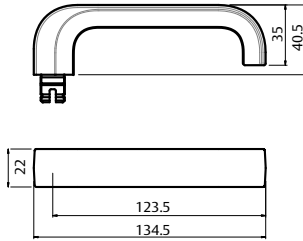

Lever 132

| | |
|-------------------------|--------|
| Length | 130mm |
| Projection | 57.5mm |
| Finger clearance | 28.4mm |

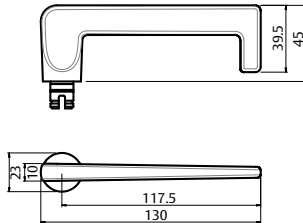

Lever 133

| | |
|-------------------------|--------|
| Length | 130mm |
| Projection | 53.5mm |
| Finger clearance | 28.4mm |

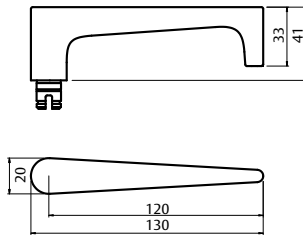

Lever 142

| | |
|-------------------------|---------|
| Length | 130.5mm |
| Projection | 55mm |
| Finger clearance | 28.4mm |

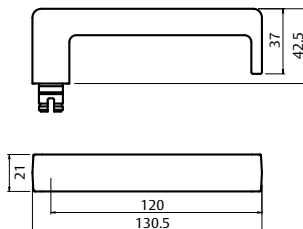

1360 Series Brass Door Handles

AS1428.1 Compliant Levers

Lever 144

| | |
|-------------------------|---------|
| Length | 128.8mm |
| Projection | 57.5mm |
| Finger clearance | 28.4mm |

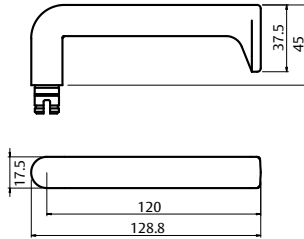

Lever 145

| | |
|-------------------------|--------|
| Length | 130mm |
| Projection | 58.5mm |
| Finger clearance | 28.4mm |

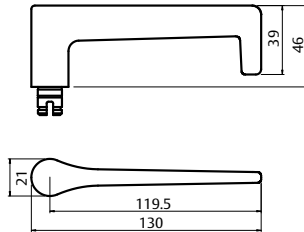

Lever 155

| | |
|-------------------------|---------|
| Length | 129.3mm |
| Projection | 57.5mm |
| Finger clearance | 28.4mm |

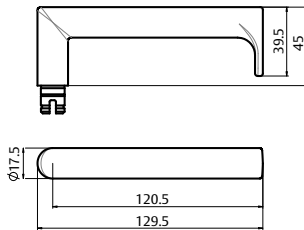

Lever 166

| | |
|-------------------------|--------|
| Length | 130mm |
| Projection | 48mm |
| Finger clearance | 28.4mm |

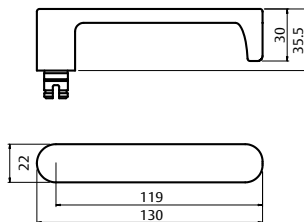

1360 Series Brass Door Handles

AS1428.1 Compliant Levers

Lever 180

| | |
|-------------------------|---------|
| Length | 123.5mm |
| Projection | 53.1mm |
| Finger clearance | 28.4mm |

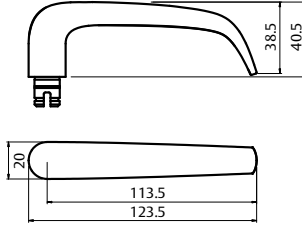

Lever 47

| | |
|-------------------------|--------|
| Length | 120mm |
| Projection | 49.6mm |
| Finger clearance | 40mm |

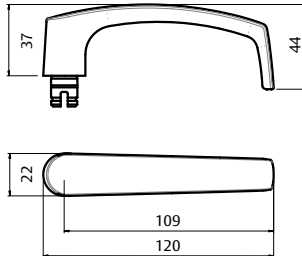

Lever 59

| | |
|-------------------------|--------|
| Length | 121mm |
| Projection | 57.5mm |
| Finger clearance | 38mm |

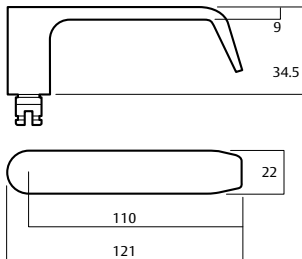

Lever 70

| | |
|-------------------------|-------|
| Length | 121mm |
| Projection | 53mm |
| Finger clearance | 37mm |

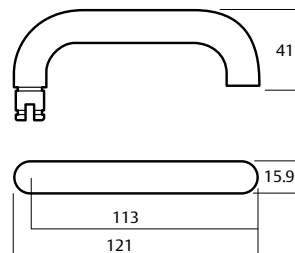

1360 Series Brass Door Handles

AS1428.1 Compliant Levers

Lever 74

| | |
|-------------------------|-------|
| Length | 120mm |
| Projection | 53mm |
| Finger clearance | 45mm |

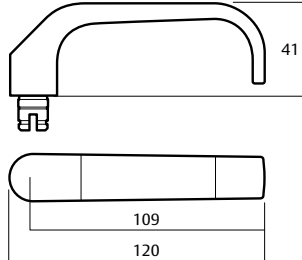

Lever 76

| | |
|-------------------------|--------|
| Length | 125mm |
| Projection | 48.5mm |
| Finger clearance | 28.4mm |

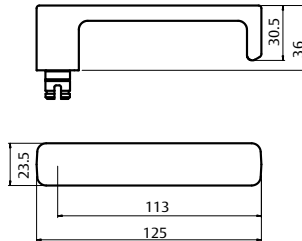

Lever 77

| | |
|-------------------------|--------|
| Length | 121mm |
| Projection | 51mm |
| Finger clearance | 40.5mm |

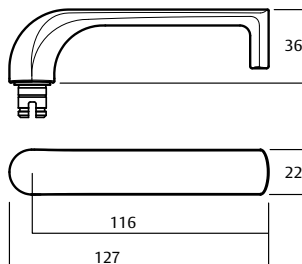

Lever 90

| | |
|-------------------------|---------|
| Length | 118.5mm |
| Projection | 52mm |
| Finger clearance | 45mm |

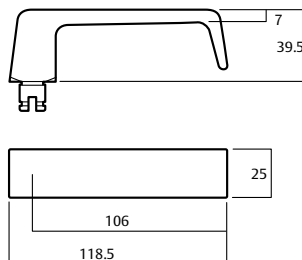

1360 Series Brass Door Handles

Non compliant lever/knob types

Lever 101

| | |
|-------------------------|--------|
| Length | 130mm |
| Projection | 48.5mm |
| Finger clearance | 28.4mm |

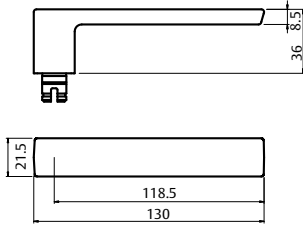

Lever 104

| | |
|-------------------------|---------|
| Length | 133.8mm |
| Projection | 57.5mm |
| Finger clearance | 28.4mm |

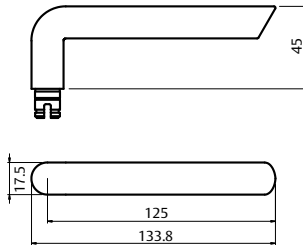

Lever 106

| | |
|-------------------------|--------|
| Length | 130mm |
| Projection | 48mm |
| Finger clearance | 28.4mm |

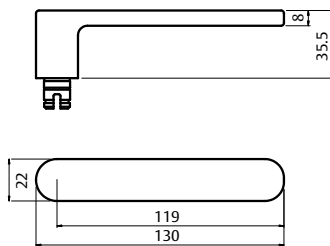

Lever 123

| | |
|-------------------------|---------|
| Length | 130.5mm |
| Projection | 59mm |
| Finger clearance | 28.4mm |

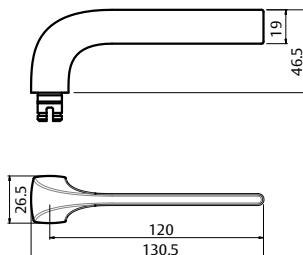

1360 Series Brass Door Handles

Non compliant lever/knob types

Lever 178

| | |
|-------------------------|--------|
| Length | 130mm |
| Projection | 63.6mm |
| Finger clearance | 28.4mm |

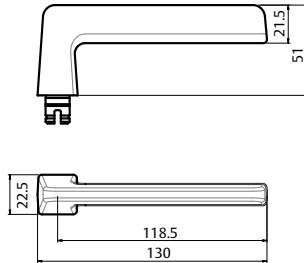

Lever 41

| | |
|-------------------------|--------|
| Length | 130mm |
| Projection | 61.5mm |
| Finger clearance | 40.5mm |

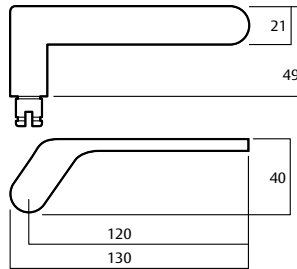

* Lever is an asymmetrical design and therefore must be handed.

Lever 97

| | |
|-------------------------|--------|
| Length | 120mm |
| Projection | 50.5mm |
| Finger clearance | 34.6mm |

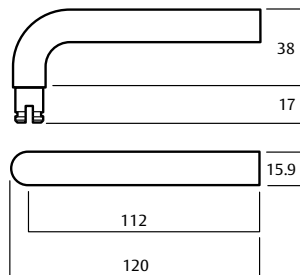

Knob 20

| | |
|-------------------|------|
| Diameter | 50mm |
| Projection | 73mm |

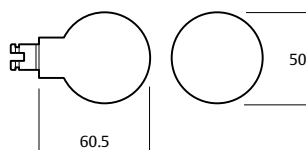

20 Knob can be used on outside rose only.

1360 Series Brass Door Handles

Handed Levers

Lever 122

| | |
|-------------------------|---------|
| Length | 130.5mm |
| Projection | 59mm |
| Finger clearance | 28.4mm |

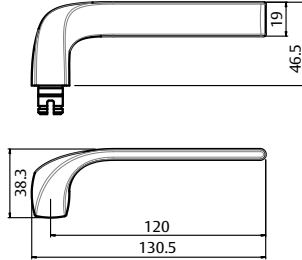

Lever 153

| | |
|-------------------------|--------|
| Length | 120mm |
| Projection | 70.6mm |
| Finger clearance | 28.4mm |

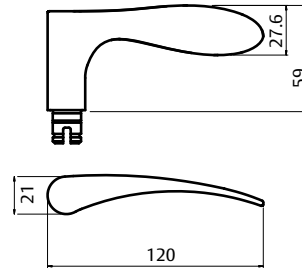

1360 Series Through Fix Escutcheon Kits

Through fix kits are optimised for use with Selector Series Mortice Locks. Supplied with two M4 64mm stainless screws for through fix installation.

Double Oval Cylinder Escutcheons Kit

Part Number 1366/6

Escutcheons supplied

Outside: Oval Cylinder Escutcheon

Inside: Oval Cylinder Escutcheon

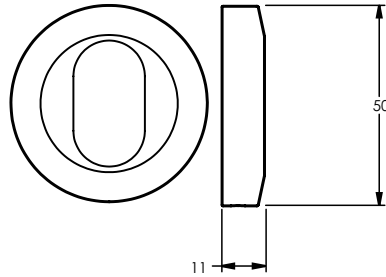

Outside

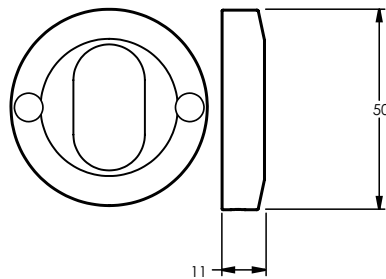

Inside

Oval Cylinder and Turnknob Escutcheons Kit

Part Number 1366/7N

Escutcheons supplied

Outside: Oval Cylinder Escutcheon

Inside: Turnknob Escutcheon

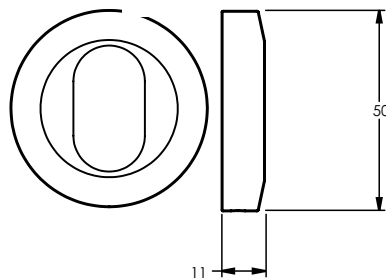

Outside

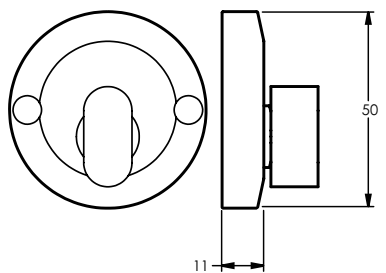

Inside

1360 Series Through Fix Escutcheon Kits

Privacy Indicating Emergency Turn and Disabled Accessible Turnknob Escutcheons Kit

Part Number 1368/9P

Escutcheons supplied

Outside: Privacy Indicating Emergency Turn Escutcheon

Inside: Privacy Indicating Disabled Accessible Turnknob Escutcheon

Note: Kits with Disabled Accessible Turnknobs require handing.

Handing is based on the door, same as handing of a full set of rose door lever handles.

A left-handed escutcheon kit suits a left-handed door and will be supplied with a right-handed disabled accessible turnknob, as this turnknob is intended to be used on the interior side of the door.

Door thickness: Suitable for 32 - 45mm doors. Extended tail bars available for thicker doors.

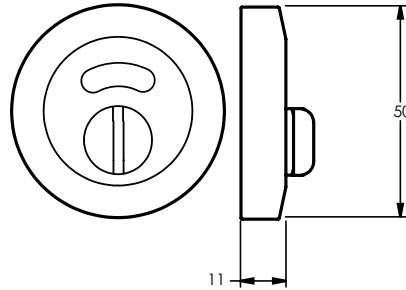

Outside

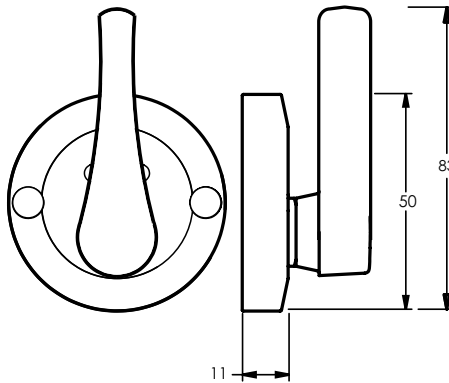

Inside

HAND OF DOOR ACCORDING TO ENGLISH PRACTICE

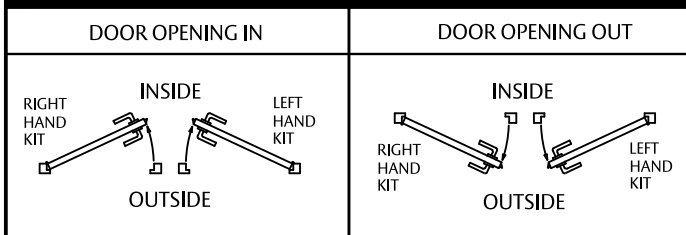

Note: Common kit configurations are shown, for other kit variations please refer to the ordering procedure at the end of this section.

1360 Series Cylinder & Turn Escutcheons

Surface mounted escutcheons are optimised for use with Synergy Series Mortice Locks.

Oval Cylinder Escutcheon

Part Number 1366/E

Supplied with

- 2 x M4 x 65mm Stainless Steel Screws (SP1220-119)
- 1 x Allen Key (SP1366-14)
- 1 x Grub Screw M4 x 8mm (SPV0272 PBK)

(Replaces 1366)

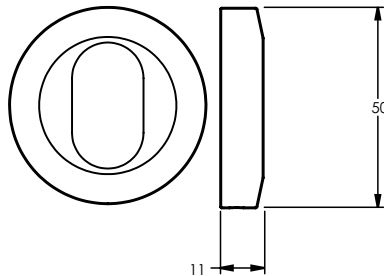

Turnknob Escutcheon

Part Number 1367/IN

Supplied with

- 2 x Short & 2 x Medium Wood Screws (SP1226-219)
- 1 x Short, Medium & Long Tail Bars and Spring (SP1227-219)
- 1 x Flat Tail Bar & Split Pin (SP1227-319)
- 1 x Instructions (1220-321)

(Replaces 1367)

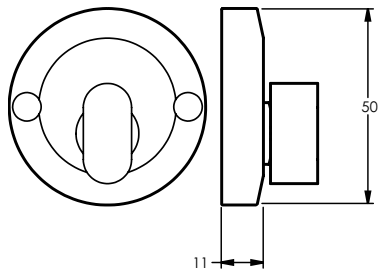

Privacy Indicating Turnknob Escutcheon

Part Number 1367/IP

Supplied with

- 2 x Short & 2 x Medium Wood Screws (SP1226-219)
- 1 x Short, Medium & Long Tail Bars and Spring (SP1227-219)
- 1 x Flat Tail Bar & Split Pin (SP1227-319)
- 1 x Instructions (1220-321)

(Replaces 1367P)

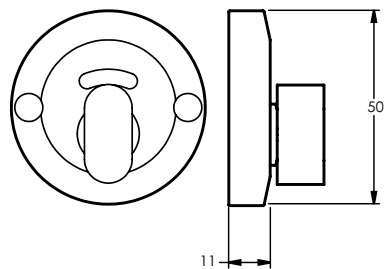

Emergency Turn Escutcheon

Part Number 1368/IN

Supplied with

- 2 x Short & 2 x Medium Wood Screws (SP1226-219)
- 1 x Emergency Tail Bar (SP1227-119)

(Replaces 1368)

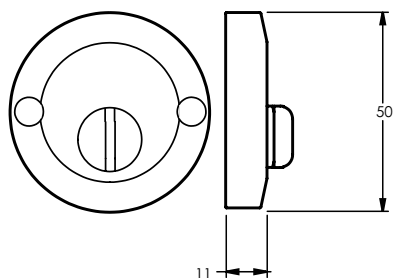

1360 Series Cylinder & Turn Escutcheons

Privacy Indicating Emergency Turn Escutcheon

Part Number 1368/IP

Supplied with

2 x Short & 2 x Medium Wood Screws (SP1226-219)
1 x Emergency Tail Bar (SP1227-119)

(Replaces 1368P)

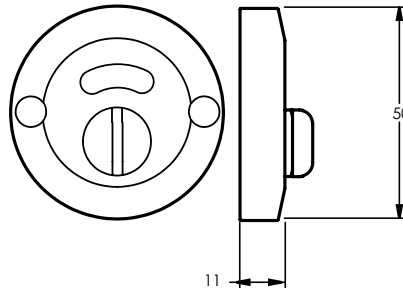

Disabled Accessible Turnknob

Part Number 1369/IN

Supplied with

2 x Short & 2 x Medium Wood Screws (SP1226-219)
1 x Short, Medium & Long Tail Bars and Spring (SP1227-219)
1 x Instructions (1220-321)

Note: Specify handing.

(Replaces 1367DT)

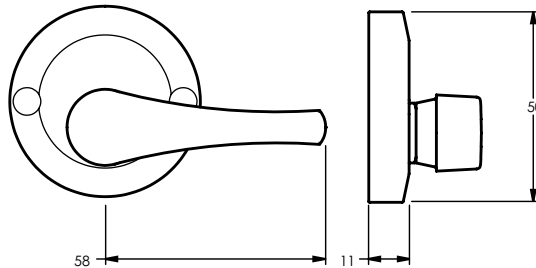

Disabled Accessible Privacy Indicating Turnknob

Part Number 1369/IP

Supplied with

2 x Short & 2 x Medium Wood Screws (SP1226-219)
1 x Short, Medium & Long Tail Bars and Spring (SP1227-219)
1 x Instructions (1220-321)

Note: Specify handing.

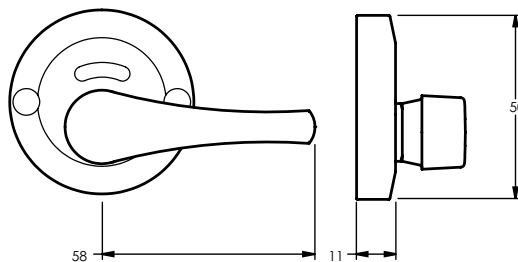

Door thickness: Suitable for 32 - 45mm doors.
Extended tail bars available for thicker doors.

1360 Series Ordering Procedure

Ordering Procedure

Sample part number 1360/41LCP is made up of several sections. Choose your product by selecting an option from each section.

Half Set

Note: Choose one rose only, exterior or interior.

| | | | |
|---------------|-------------|---------|--------|
| Exterior Rose | Lever/ Knob | Handing | Finish |
| 1360 | 41 | L | CP |

Full Set

| | | | | |
|---------------|---------------|-------------|---------|--------|
| Exterior Rose | Interior Rose | Lever/ Knob | Handing | Finish |
| 1360 | 1361 | 41 | L | CP |

| Exterior Rose Type | |
|---------------------|------|
| Exterior Rose | 1360 |
| Exterior Blank Rose | 1362 |
| Exterior Fixed Rose | 1364 |

| Interior Rose Type | |
|---------------------|------|
| Interior Rose | 1361 |
| Interior Blank Rose | 1363 |
| Interior Fixed Rose | 1365 |

| AS1428.1 Compliant Lever Types | | |
|--------------------------------|-----|-----|
| 102 | 111 | 112 |
| 115 | 116 | 118 |
| 124 | 131 | 132 |
| 133 | 142 | 144 |
| 145 | 155 | 166 |
| 47 | 59 | 70 |
| 74 | 76 | 77 |
| 90 | | |

| Non compliant lever/knob types | | |
|--------------------------------|-----|-----|
| 101 | 104 | 123 |
| 178 | 41 | 97 |
| 20 | | |

| Handed Levers | |
|---------------|-----|
| 122 | 153 |

| Handing | |
|------------------------|---|
| Right Handed | R |
| Left Handed | L |
| NB: Omit if non-handed | |

| Finish | |
|----------------------|----|
| Satin Chrome Brushed | SC |
| Chrome Plate | CP |
| Polished Brass | PB |
| Polyester Powdercoat | PC |

| Non - Standard Finishes | |
|----------------------------------|-----|
| Polished Brass Unlacquered | BU |
| Satin Brass | SB |
| Satin Brass Unlacquered | SBU |
| Architectural Bronze | AZ |
| Architectural Bronze Unlacquered | AU |
| Antique Copper | AC |
| Oil Rubbed Bronze | ORB |

Note: Refer to the decorative finishes section at the end of this catalogue for images of the full metal finishes and powder coat colour range available.

1360 Series Ordering Procedure

Selector Series Escutcheon Kits

Through fix kits are optimised for use with Selector Series Mortice Locks. Supplied with two M4 64mm stainless screws for through fix installation.

Sample part number 1366/9NLSC is made up of several sections. The description of this part number is a left-handed oval cylinder and disabled accessible turnknob escutcheon kit.

| | | | | |
|-------------------|-------------------|-------------------|---------|--------|
| Exterior Function | Interior Function | Privacy Indicator | Handing | Finish |
| 1366 | 9 | N | L | SC |

| Exterior Function | |
|-------------------|------|
| Oval Cylinder | 1366 |
| Emergency Turn | 1368 |

Notes:

Order 1366/E if only one oval cylinder escutcheon is required. A grub screw will be supplied to allow for concealed fixing.

1368/6 Kit is not applicable.

| Interior Function | |
|------------------------------|---|
| Oval Cylinder | 6 |
| Oval Turnknob | 7 |
| Disabled Accessible Turnknob | 9 |

| Privacy Indicator | |
|--------------------|---|
| Oval Cylinder | - |
| Non Indicating | N |
| Privacy Indicating | P |

Note:

Privacy indicator applies for both exterior and interior functions.

| Handing | |
|--------------|---|
| Right Handed | R |
| Left Handed | L |

Note:

Handing is based on the door, same as handing of a full set of rose door lever handles.

The sample part number shown above suits a left-handed door. This kit will be supplied with a right-handed disabled accessible turnknob, as the turnknob is intended to be used on the interior side of the door.

Only Kits with Disabled Accessible Turnknobs require handing.

| Finish | |
|----------------------|----|
| Satin Chrome Brushed | SC |
| Chrome Plate | CP |
| Polished Brass | PB |
| Polyester Powdercoat | PC |

Non - Standard Finishes

| | |
|----------------------------------|-----|
| Polished Brass Unlacquered | BU |
| Satin Brass | SB |
| Satin Brass Unlacquered | SBU |
| Architectural Bronze | AZ |
| Architectural Bronze Unlacquered | AU |
| Antique Copper | AC |
| Oil Rubbed Bronze | ORB |

Note: Refer to the decorative finishes section at the end of this catalogue for images of the full metal finishes and powder coat colour range available.

1360 Series Ordering Procedure

Synergy Series Escutcheons

Surface mounted escutcheons are optimised for use with Synergy Series Mortice Locks.

Supplied with wood screws to suit surface mounting on either side of the door.

| | | | | |
|-----------------|--------|-------------------|---------|--------|
| Escutcheon Type | Fixing | Privacy Indicator | Handing | Finish |
| 1369 | I | P | L | SC |

| Escutcheon Type | |
|--------------------------|-------|
| Oval Cylinder | 1366 |
| Oval Turn | 1367 |
| Emergency Turn | 1368 |
| Disabled Accessible Turn | 1369* |

Note:
*Cannot be used with Selector Mortice Locks, please order escutcheon kits if needed.

| Fixing | |
|-----------------------------|----|
| Wood Screw Surface Fixing | I |
| Grub Screw Concealed Fixing | E* |

Note:
*Only applicable when ordering with 1366 Oval Cylinder Escutcheon. The 1366/E will be supplied with a grub screw to allow for concealed fixing.

| Privacy Indicator | |
|--------------------|---|
| Oval Cylinder | - |
| Non Indicating | N |
| Privacy Indicating | P |

| Handing | |
|-------------|---|
| Left Handed | L |
| Right Hand | R |

NB: Only Disabled Accessible Turnknobs require handing

| Finish | |
|----------------------|----|
| Satin Chrome Brushed | SC |
| Chrome Plate | CP |
| Polished Brass | PB |
| Polyester Powdercoat | PC |

| Special Finishes | |
|----------------------------------|-----|
| Polished Brass Unlacquered | BU |
| Satin Brass | SB |
| Satin Brass Unlacquered | SBU |
| Architectural Bronze | AZ |
| Architectural Bronze Unlacquered | AU |
| Antique Copper | AC |
| Oil Rubbed Bronze | ORB |

Note: Refer to the decorative finishes section at the end of this catalogue for images of the full metal finishes and powder coat colour range available.

1370 Series Brass Door Handles



Lockwood 1370 Series door furniture is manufactured from high quality solid brass material. The comprehensive lever range matched with ease of installation and compatibility with a wide range of Mortice Locks defines simple and reliable.

The accessory range includes cylinder escutcheons, emergency turns and disabled accessible turnknobs. For installers, the unique turn mechanism adjusts to suit the thickness of the door and removes the need to cut tailbars to length.

A full range of finishes from satin chrome through to a range of brass finishes and polyester powder coat provides all the options for matching to interior designs.

Proudly Australian Made at our factory at Oakleigh to the highest quality standards for strength, durability and corrosion resistance.

Product Details

| | |
|----------------------------|--|
| Dimensions | 62.5mm diameter x 11.6mm. |
| Materials | All Lockwood roses and levers contained in the 1370 series are of solid brass construction. |
| Fixing | Roses are designed to fit back to back. If outside rose is specified with concealed fixing, then the inside rose must be visible fixed. Roses numbered 1370, 1372 and 1374 are concealed fixed, roses numbered 1371, 1373 and 1375 are visible fixed. |
| Door Thickness | Selector 3770 and Synergy 3570 Series: 32mm to 50mm Lockwood 5260 Latches: 33mm to 50mm |
| Decorative Finishes | <p>Standard Finish: Satin Chrome Brushed (SC)</p> <p>Non-Standard Finish: Chrome Plate (CP) Polished Brass (PB) Polyester Powdercoat (PC)</p> <p>Special Finish: Architectural Bronze (AZ) Architectural Bronze Unlacquered (AU) Antique Copper (AC) Polished Brass Unlacquered (BU) Satin Brass (SB) Oil Rubbed Bronze (ORB) Satin Brass Unlacquered (SBU)</p> |

Standards and Compliance



1370 Series has been successfully tested up to 4 hours with a fire rated Lockwood mortice lock on fire door assemblies (depending on type of doorset) in accordance with Australian Standard AS1905.1:2005, Fire Resistant Doorsets.

1370 Series lever sets have been successfully tested to conform with Level D8 (500,000 cycles) under Australian Standard AS4145.2-2008, Locksets and hardware for doors and windows.

D8



1370 Series lever sets in satin chrome finish has been successfully tested to AS 4145.2 2008 for Neutral Salt Spray – With SC Finish passing C10 1000 Hours - Extreme Corrosion Resistance. Suitable for coastal applications.



1370 Series includes levers and turns (as shown) that meet the requirements of AS1428.1-2009, Design for access and mobility.

Lockwood Brass Door Furniture is designed, assembled and customised in Australia to suit the requirements of the Australian Market.

1370 Series Brass Door Handles

BRASS CORE

The 1370 Series rose furniture features a 62mm solid brass rose with diagonal screw fixings, concealed on the outside and visible on the inside.

Supplied with:

2 x M4 x 65mm Stainless Steel Screws (SP1220-119)
1 x Instructions (1220-221)

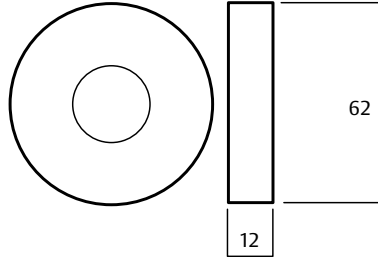

AS1428.1 Compliant Levers

Lever 102

| | |
|-------------------------|---------|
| Length | 134.3mm |
| Projection | 57.5mm |
| Finger clearance | 28.4mm |

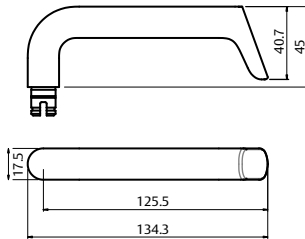

Lever 111

| | |
|-------------------------|--------|
| Length | 130mm |
| Projection | 48.5mm |
| Finger clearance | 28.4mm |

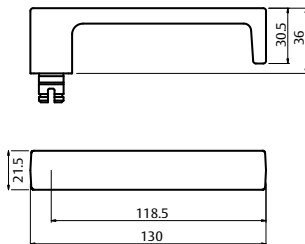

Lever 112

| | |
|-------------------------|---------|
| Length | 130.5mm |
| Projection | 48mm |
| Finger clearance | 28.4mm |

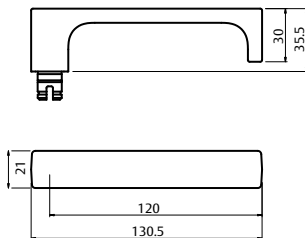

1370 Series Brass Door Handles

AS1428.1 Compliant Levers

Lever 115

| | |
|-------------------------|---------|
| Length | 140.4mm |
| Projection | 60mm |
| Finger clearance | 28.4mm |

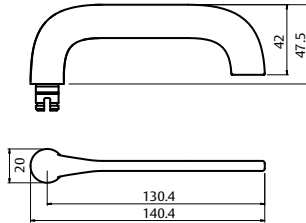

Lever 116

| | |
|-------------------------|---------|
| Length | 140.5mm |
| Projection | 47.6mm |
| Finger clearance | 28.4mm |

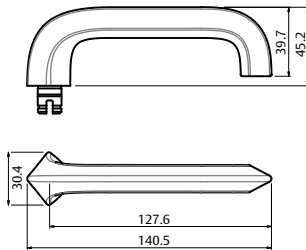

Lever 118

| | |
|-------------------------|--------|
| Length | 128mm |
| Projection | 58mm |
| Finger clearance | 28.4mm |

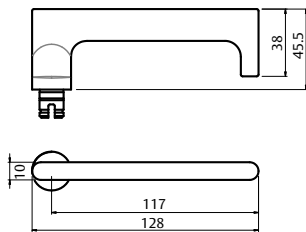

Lever 124

| | |
|-------------------------|---------|
| Length | 130.5mm |
| Projection | 59mm |
| Finger clearance | 28.4mm |

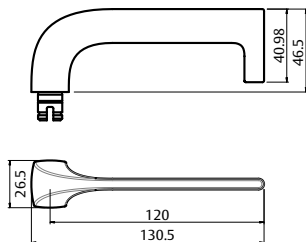

1370 Series Brass Door Handles

AS1428.1 Compliant Levers

Lever 131

| | |
|-------------------------|---------|
| Length | 134.5mm |
| Projection | 53mm |
| Finger clearance | 28.4mm |

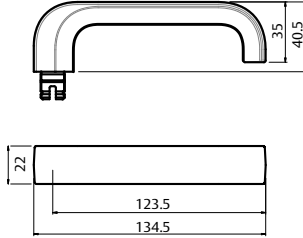

Lever 132

| | |
|-------------------------|--------|
| Length | 130mm |
| Projection | 57.5mm |
| Finger clearance | 28.4mm |

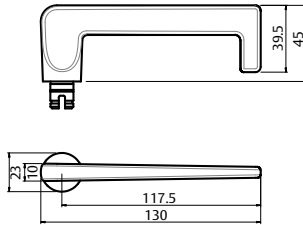

Lever 133

| | |
|-------------------------|--------|
| Length | 130mm |
| Projection | 53.5mm |
| Finger clearance | 28.4mm |

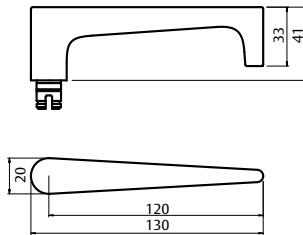

Lever 142

| | |
|-------------------------|---------|
| Length | 130.5mm |
| Projection | 55mm |
| Finger clearance | 28.4mm |

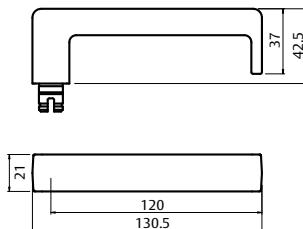

1370 Series Brass Door Handles

AS1428.1 Compliant Levers

| Lever 144 | |
|-------------------------|---------|
| Length | 128.8mm |
| Projection | 57.5mm |
| Finger clearance | 28.4mm |

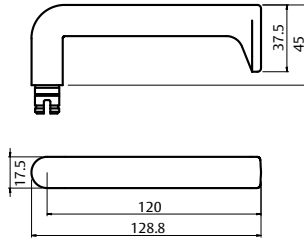

| Lever 145 | |
|-------------------------|--------|
| Length | 130mm |
| Projection | 58.5mm |
| Finger clearance | 28.4mm |

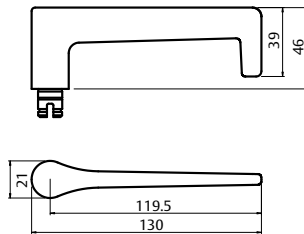

| Lever 155 | |
|-------------------------|---------|
| Length | 129.3mm |
| Projection | 57.5mm |
| Finger clearance | 28.4mm |

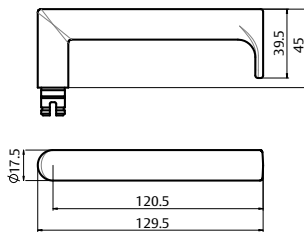

| Lever 166 | |
|-------------------------|--------|
| Length | 130mm |
| Projection | 48mm |
| Finger clearance | 28.4mm |

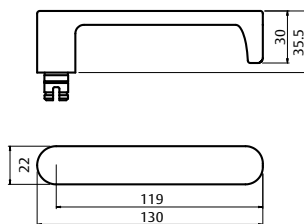

1370 Series Brass Door Handles

AS1428.1 Compliant Levers

Lever 180

| | |
|-------------------------|---------|
| Length | 123.5mm |
| Projection | 53.1mm |
| Finger clearance | 28.4mm |

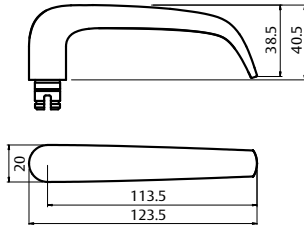

Lever 47

| | |
|-------------------------|--------|
| Length | 120mm |
| Projection | 49.6mm |
| Finger clearance | 40mm |

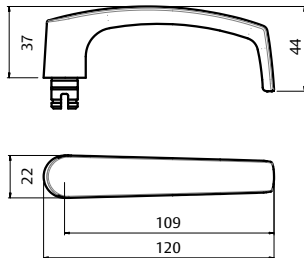

Lever 59

| | |
|-------------------------|--------|
| Length | 121mm |
| Projection | 57.5mm |
| Finger clearance | 38mm |

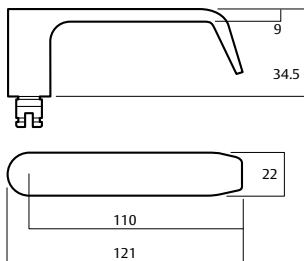

Lever 70

| | |
|-------------------------|-------|
| Length | 121mm |
| Projection | 53mm |
| Finger clearance | 37mm |

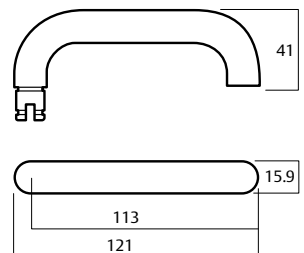

1370 Series Brass Door Handles

AS1428.1 Compliant Levers

| Lever 74 | |
|-------------------------|-------|
| Length | 120mm |
| Projection | 53mm |
| Finger clearance | 45mm |

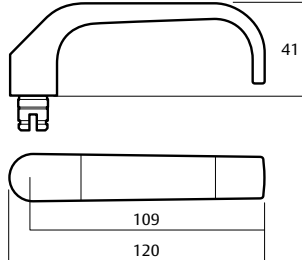

| Lever 76 | |
|-------------------------|--------|
| Length | 125mm |
| Projection | 48.5mm |
| Finger clearance | 28.4mm |

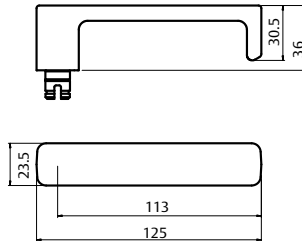

| Lever 77 | |
|-------------------------|--------|
| Length | 121mm |
| Projection | 51mm |
| Finger clearance | 40.5mm |

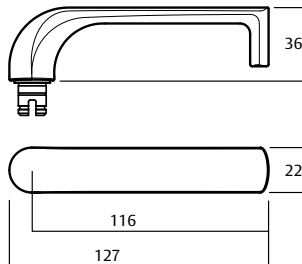

| Lever 90 | |
|-------------------------|---------|
| Length | 118.5mm |
| Projection | 52mm |
| Finger clearance | 45mm |

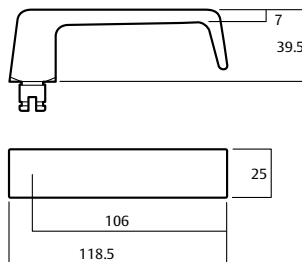

1370 Series Brass Door Handles

Non compliant lever/knob types

Lever 101

| | |
|-------------------------|--------|
| Length | 130mm |
| Projection | 48.5mm |
| Finger clearance | 28.4mm |

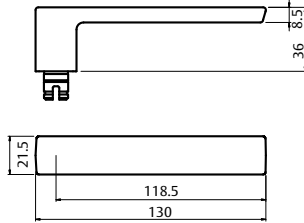

Lever 104

| | |
|-------------------------|---------|
| Length | 133.8mm |
| Projection | 57.5mm |
| Finger clearance | 28.4mm |

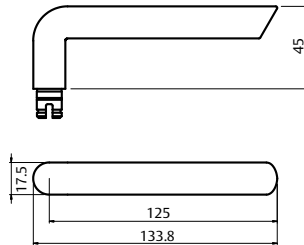

Lever 106

| | |
|-------------------------|--------|
| Length | 130mm |
| Projection | 48mm |
| Finger clearance | 28.4mm |

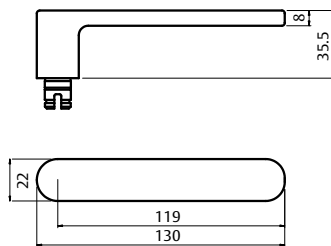

Lever 123

| | |
|-------------------------|---------|
| Length | 130.5mm |
| Projection | 59mm |
| Finger clearance | 28.4mm |

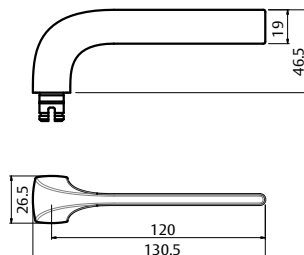

1370 Series Brass Door Handles

Non compliant lever/knob types

| Lever 178 | |
|-------------------------|--------|
| Length | 130mm |
| Projection | 63.6mm |
| Finger clearance | 28.4mm |

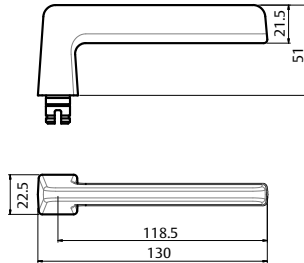

| Lever 41 | |
|-------------------------|--------|
| Length | 130mm |
| Projection | 61.5mm |
| Finger clearance | 40.5mm |

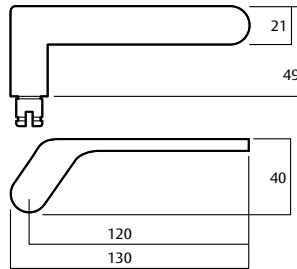

* Lever is an asymmetrical design and therefore must be handed.

| Lever 97 | |
|-------------------------|--------|
| Length | 120mm |
| Projection | 50.5mm |
| Finger clearance | 34.6mm |

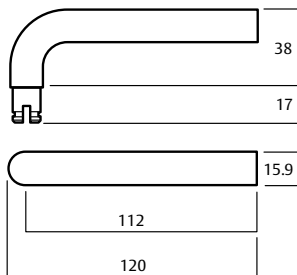

| Knob 20 | |
|-------------------|------|
| Diameter | 50mm |
| Projection | 73mm |

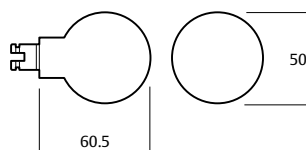

20 Knob can be used on outside rose only.

1370 Series Brass Door Handles

Handed Levers

Lever 122

| | |
|-------------------------|---------|
| Length | 130.5mm |
| Projection | 59mm |
| Finger clearance | 28.4mm |

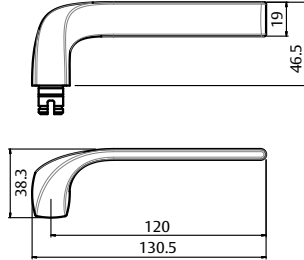

Lever 153

| | |
|-------------------------|--------|
| Length | 120mm |
| Projection | 70.6mm |
| Finger clearance | 28.4mm |

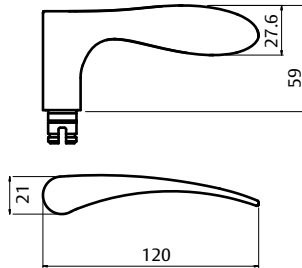

1370 Series Through Fix Escutcheon Kits

Through fix kits are optimised for use with Selector Series Mortice Locks. Supplied with two M4 64mm stainless screws for through fix installation.

Double Oval Cylinder Escutcheons Kit

Part Number 1376/6

Escutcheons supplied

Outside: Oval Cylinder Escutcheon

Inside: Oval Cylinder Escutcheon

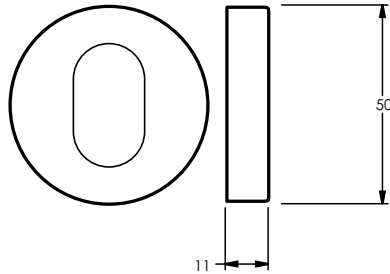

Outside

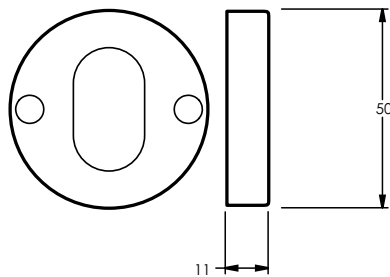

Inside

Oval Cylinder and Turnknob Escutcheons Kit

Part Number 1376/7N

Escutcheons supplied

Outside: Oval Cylinder Escutcheon

Inside: Turnknob Escutcheon

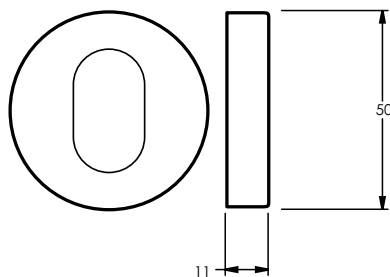

Outside

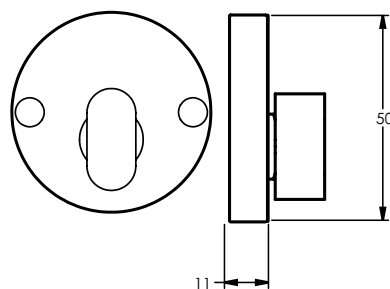

Inside

1370 Series Through Fix Escutcheon Kits

Privacy Indicating Emergency Turn and Disabled Accessible Turnknob Escutcheons Kit

Part Number 1378/9P

Escutcheons supplied

Outside: Privacy Indicating Emergency Turn Escutcheon

Inside: Privacy Indicating Disabled Accessible Turnknob Escutcheon

Note: Kits with Disabled Accessible Turnknobs require handing.

Handing is based on the door, same as handing of a full set of rose door lever handles.

A left-handed escutcheon kit suits a left-handed door and will be supplied with a right-handed disabled accessible turnknob, as this turnknob is intended to be used on the interior side of the door.

Door thickness: Suitable for 32 - 45mm doors. Extended tail bars available for thicker doors.

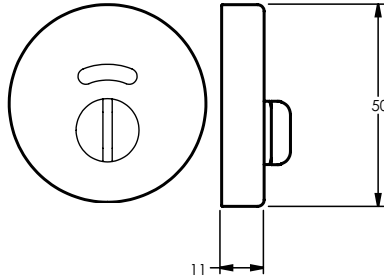

Outside

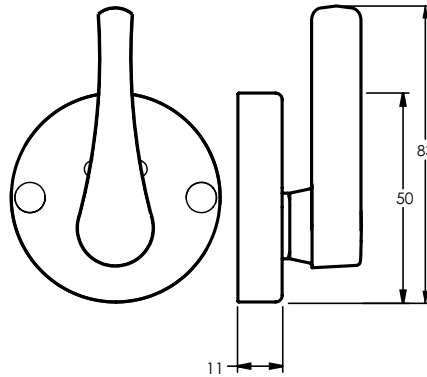

Inside

HAND OF DOOR ACCORDING TO ENGLISH PRACTICE

| DOOR OPENING IN | | DOOR OPENING OUT | |
|-----------------|---------------|------------------|---------------|
| INSIDE | INSIDE | INSIDE | INSIDE |
| RIGHT HAND KIT | LEFT HAND KIT | RIGHT HAND KIT | LEFT HAND KIT |
| OUTSIDE | OUTSIDE | OUTSIDE | OUTSIDE |

Note: Common kit configurations are shown, for other kit variations please refer to the ordering procedure at the end of this section.

1370 Series Cylinder & Turn Escutcheons

Surface mounted escutcheons are optimised for use with Synergy Series Mortice Locks.

Oval Cylinder Escutcheon

Part Number 1376/E

Supplied with

- 2 x M4 x 65mm Stainless Steel Screws (SP1220-119)
- 1 x Allen Key (SP1366-14)
- 1 x Grub Screw M4 x 8mm (SPV0272 PBK)

(Replaces 1376)

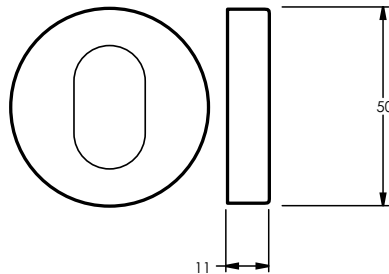

Turnknob Escutcheon

Part Number 1377/IN

Supplied with

- 2 x Short & 2 x Medium Wood Screws (SP1226-219)
- 1 x Short, Medium & Long Tail Bars and Spring (SP1227-219)
- 1 x Flat Tail Bar & Split Pin (SP1227-319)
- 1 x Instructions (1220-321)

(Replaces 1377)

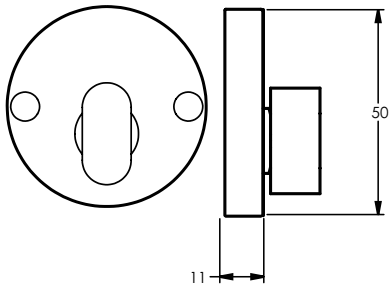

Privacy Indicating Turnknob Escutcheon

Part Number 1377/IP

Supplied with

- 2 x Short & 2 x Medium Wood Screws (SP1226-219)
- 1 x Short, Medium & Long Tail Bars and Spring (SP1227-219)
- 1 x Flat Tail Bar & Split Pin (SP1227-319)
- 1 x Instructions (1220-321)

(Replaces 1377P)

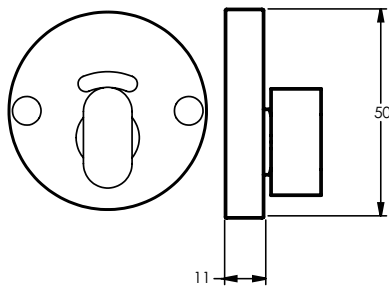

Emergency Turn Escutcheon

Part Number 1378/IN

Supplied with

- 2 x Short & 2 x Medium Wood Screws (SP1226-219)
- 1 x Emergency Tail Bar (SP1227-119)

(Replaces 1378)

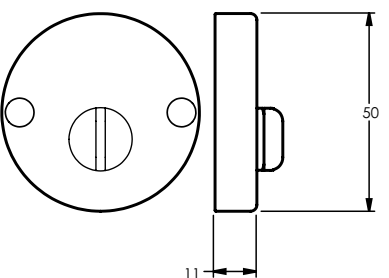

1370 Series Cylinder & Turn Escutcheons

Privacy Indicating Emergency Turn Escutcheon

Part Number 1378/IP

Supplied with

2 x Short & 2 x Medium Wood Screws (SP1226-219)
1 x Emergency Tail Bar (SP1227-119)

(Replaces 1378P)

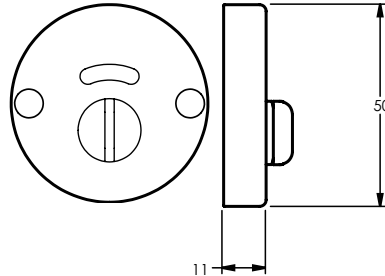

Disabled Accessible Turnknob

Part Number 1379/IN

Supplied with

2 x Short & 2 x Medium Wood Screws (SP1226-219)
1 x Short, Medium & Long Tail Bars and Spring (SP1227-219)
1 x Instructions (1220-321)

Note: Specify handing

(Replaces 1377DT)

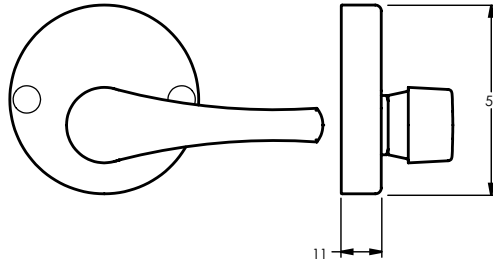

Disabled Accessible Privacy Indicating Turnknob

Part Number 1379/IP

Supplied with

2 x Short & 2 x Medium Wood Screws (SP1226-219)
1 x Short, Medium & Long Tail Bars and Spring (SP1227-219)
1 x Instructions (1220-321)

Note: Specify handing

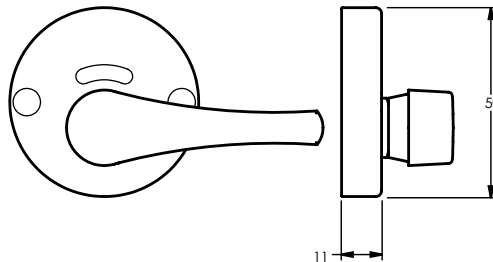

Door thickness: Suitable for 32 - 45mm doors.
Extended tail bars available for thicker doors.

1370 Series Ordering Procedure

Sample part number 1370/1371/41LCP is made up of several sections. Choose your product by selecting an option from each section.

Half Set

Note: Choose one rose only, exterior or interior.

| | | | |
|---------------|-------------|---------|--------|
| Exterior Rose | Lever/ Knob | Handing | Finish |
| 1370 | 41 | L | CP |

Full Set

| | | | | |
|---------------|---------------|-------------|---------|--------|
| Exterior Rose | Interior Rose | Lever/ Knob | Handing | Finish |
| 1370 | 1371 | 41 | L | CP |

| Exterior Rose Type | |
|---------------------|------|
| Exterior Rose | 1370 |
| Exterior Blank Rose | 1372 |
| Exterior Fixed Rose | 1374 |

| Interior Rose Type | |
|---------------------|------|
| Interior Rose | 1371 |
| Interior Blank Rose | 1373 |
| Interior Fixed Rose | 1375 |

| AS1428.1 Compliant Lever Types | | |
|--------------------------------|-----|-----|
| 102 | 111 | 112 |
| 115 | 116 | 118 |
| 124 | 131 | 132 |
| 133 | 142 | 144 |
| 145 | 155 | 166 |
| 47 | 59 | 70 |
| 74 | 76 | 77 |
| 90 | | |

| Non compliant lever/knob types | | |
|--------------------------------|-----|-----|
| 101 | 104 | 123 |
| 178 | 41 | 97 |
| 20 | | |

| Handed Levers | |
|---------------|-----|
| 122 | 153 |

| Handing | |
|------------------------|---|
| Right Handed | R |
| Left Handed | L |
| NB: Omit if non-handed | |

| Finish | |
|----------------------|----|
| Satin Chrome Brushed | SC |
| Chrome Plate | CP |
| Polished Brass | PB |
| Polyester Powdercoat | PC |

| Non - Standard Finishes | |
|----------------------------------|-----|
| Polished Brass Unlacquered | BU |
| Satin Brass | SB |
| Satin Brass Unlacquered | SBU |
| Architectural Bronze | AZ |
| Architectural Bronze Unlacquered | AU |
| Antique Copper | AC |
| Oil Rubbed Bronze | ORB |

Note: Refer to the decorative finishes section at the end of this catalogue for images of the full metal finishes and powder coat colour range available.

1370 Series Ordering Procedure

Selector Series Escutcheon Kits

Through fix kits are optimised for use with Selector Series Mortice Locks. Supplied with two M4 64mm stainless screws for through fix installation.

Sample part number 1376/9NLSC is made up of several sections. The description of this part number is a left-handed oval cylinder and disabled accessible turnknob escutcheon kit.

| | | | | |
|-------------------|---------------|-------------------|---------|--------|
| Exterior Function | Interior Rose | Privacy Indicator | Handing | Finish |
| 1376 | 9 | N | L | SC |

| Exterior Function | |
|-------------------|------|
| Oval Cylinder | 1376 |
| Emergency Turn | 1378 |

Notes:
Order 1376/E if only one oval cylinder escutcheon is required. A grub screw will be supplied to allow for concealed fixing.

1378/6 Kit is not applicable.

| Interior Function | |
|------------------------------|---|
| Oval Cylinder | 6 |
| Oval Turnknob | 7 |
| Disabled Accessible Turnknob | 9 |

| Privacy Indicator | |
|--------------------|---|
| Oval Cylinder | - |
| Non Indicating | N |
| Privacy Indicating | P |

Note:
Privacy indicator applies for both exterior and interior functions.

| Handing | |
|--------------|---|
| Right Handed | R |
| Left Handed | L |

Note:
Handing is based on the door, same as handing of a full set of rose door lever handles.

The sample part number shown above suits a left-handed door. This kit will be supplied with a right-handed disabled accessible turnknob, as the turnknob is intended to be used on the interior side of the door.

Only Kits with Disabled Accessible Turnknobs require handing.

| Finish | |
|----------------------|----|
| Satin Chrome Brushed | SC |
| Chrome Plate | CP |
| Polished Brass | PB |
| Polyester Powdercoat | PC |

| Special Finishes | |
|----------------------------------|-----|
| Polished Brass Unlacquered | BU |
| Satin Brass | SB |
| Satin Brass Unlacquered | SBU |
| Architectural Bronze | AZ |
| Architectural Bronze Unlacquered | AU |
| Antique Copper | AC |
| Oil Rubbed Bronze | ORB |

Note: Refer to the decorative finishes section at the end of this catalogue for images of the full metal finishes and powder coat colour range available.

1370 Series Ordering Procedure

Synergy Series Escutcheons

Surface mounted escutcheons are optimised for use with Synergy Series Mortice Locks.

Supplied with wood screws to suit surface mounting on either side of the door.

| | | | | |
|-----------------|--------|-------------------|---------|--------|
| Escutcheon Type | Fixing | Privacy Indicator | Handing | Finish |
| 1379 | I | P | L | SC |

| Escutcheon Type | |
|--------------------------|-------|
| Oval Cylinder | 1376 |
| Oval Turn | 1377 |
| Emergency Turn | 1378 |
| Disabled Accessible Turn | 1379* |

Note:
*Cannot be used with Selector Mortice Locks, please order escutcheon kits if needed.

| Fixing | |
|-----------------------------|----|
| Wood Screw Surface Fixing | I |
| Grub Screw Concealed Fixing | E* |

Note:
*Only applicable when ordering with 1376 Oval Cylinder Escutcheon. The 1376/E will be supplied with a grub screw to allow for concealed fixing.

| Privacy Indicator | |
|--------------------|---|
| Oval Cylinder | - |
| Non Indicating | N |
| Privacy Indicating | P |

| Handing | |
|--|---|
| Left Handed | L |
| Right Hand | R |
| NB: Only Disabled Accessible Turnknobs require handing | |

| Finish | |
|----------------------|----|
| Satin Chrome Brushed | SC |
| Chrome Plate | CP |
| Polished Brass | PB |
| Polyester Powdercoat | PC |

| Special Finishes | |
|----------------------------------|-----|
| Polished Brass Unlacquered | BU |
| Satin Brass | SB |
| Satin Brass Unlacquered | SBU |
| Architectural Bronze | AZ |
| Architectural Bronze Unlacquered | AU |
| Antique Copper | AC |
| Oil Rubbed Bronze | ORB |

Note: Refer to the decorative finishes section at the end of this catalogue for images of the full metal finishes and powder coat colour range available.

260 Series Door Handles

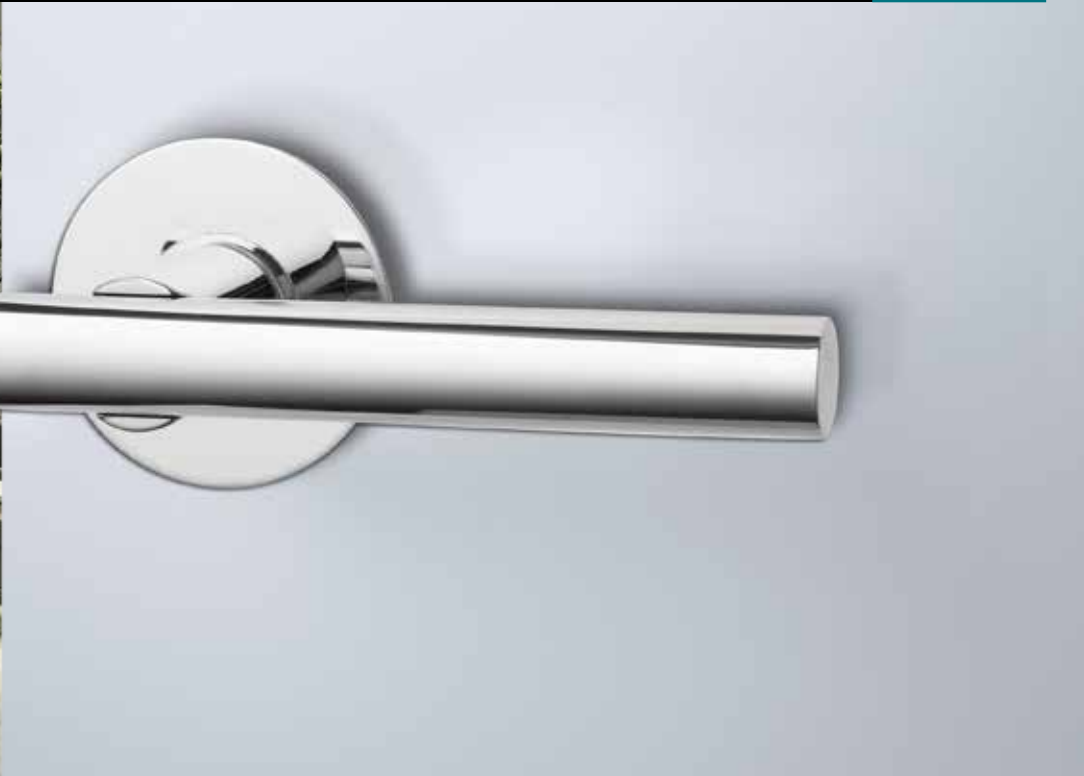

The 260 Series door furniture has a 55mm round rose. Concealed fixed plates have studs with internal threads located on the rose, visible roses have corresponding countersunk holes and are fixed back to back through the door.

Application

Designed for use with Lockwood 3770 and 3570 Series Mortice Latches and with 5260 Tubular Latches.

Product Details

| | |
|------------------------------|---|
| Dimensions | Lever Rose 55 x 3mm - aluminium 55 x 2mm - stainless steel and brass Escutcheon Rose 50 x 3mm - aluminium 50 x 2mm - stainless steel and brass |
| | Materials Aluminium, stainless steel or brass |
| Door Thickness | For use with 3570 Series Mortice Latches: Door thickness 35 to 45mm For use with 5260 Tubular Latches: Door thickness 37-45mm (Extended screws and packing plates available for installation on thicker and thinner doors.) |
| | Finishes Standard Stainless Steel (SS) |
| Finishes Non Standard | Polished Stainless Steel (PS) Powdercoat (PC) |

Standards and Compliance



260 Series has been successfully tested up to 4 hours with a fire rated Lockwood mortice lock on fire door assemblies (depending on type of doorset) in accordance with Australian Standard AS1905.1:2005, Fire Resistant Doorsets.

D3

260 Series lever sets have been successfully tested to conform with Level D8 (500,000 cycles) under Australian Standard AS4145.2-2008, Locksets and hardware for doors and windows.



Anti-Corrosion



260 Series includes levers and turns (as shown) that meet the requirements of AS1428.1-2009, Design for access and mobility.

Lockwood Artefact Door Furniture is designed, assembled and customised in Australia to suit the requirements of the Australian Market.

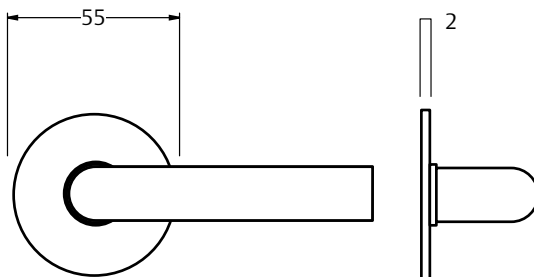

SS/Brass

260 Series Door Handle Functions

Rose Furniture 55mm Diameter

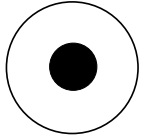

260 Operable

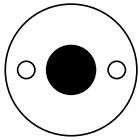

261 Operable

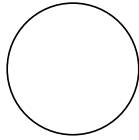

262 Blank

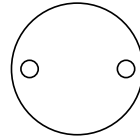

263 Blank

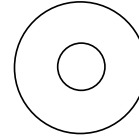

264 Fixed

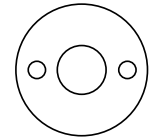

265 Fixed

Escutcheon Furniture 50mm Diameter

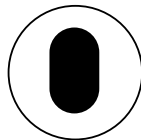

280

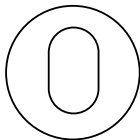

281

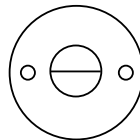

282

Functions Legend

Cylinder Hole



Turnknob



Emergency Turn



260SQ Series Square Door Rose Door Handles



The 260SQ Series door furniture has a 55mm x 2mm square rose. Concealed fixed plates have studs with internal threads located on the rose, visible roses have corresponding countersunk holes and are fixed back to back through the door.

Application

Designed for use with Lockwood 3770 and 3570 Series Mortice Latches and with 5260 Tubular Latches.

Product Details

| | |
|-----------------------|---|
| Dimensions | Lever Rose |
| | 55 x 2mm - stainless steel |
| | Escutcheon Rose |
| | 50 x 2mm - stainless steel |
| Materials | Stainless steel only |
| Door Thickness | For use with 3570 Series Mortice Latches: Door thickness 35 to 45mm |
| | For use with 5260 Tubular Latches: Door thickness 37-45mm |
| | (Extended screws and packing plates available for installation on thicker and thinner doors.) |

Finishes Standard Stainless Steel (SS)

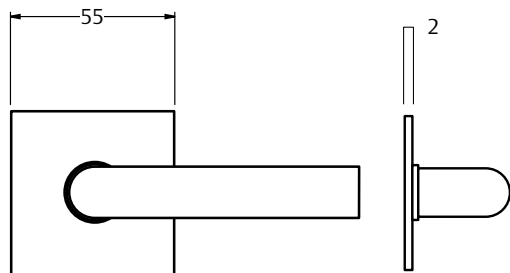

Standards and Compliance



260SQ Series has been successfully tested up to 4 hours with a fire rated Lockwood mortice lock on fire door assemblies (depending on type of doorset) in accordance with Australian Standard AS1905.1:2005, Fire Resistant Doorsets.

D3

260SQ Series lever sets have been successfully tested to conform with Level D8 (500,000 cycles) under Australian Standard AS4145.2-2008, Locksets and hardware for doors and windows.



Anti-Corrosion



260SQ Series includes levers and turns (as shown) that meet the requirements of AS1428.1-2009, Design for access and mobility.

Lockwood Artefact Door Furniture is designed, assembled and customised in Australia to suit the requirements of the Australian Market.

260SQ Series Square Door Rose Door Handles

Levers and Knob to Suit

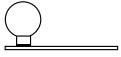

20*1

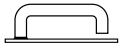

96

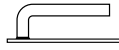

98

Square Furniture 55 x 55mm

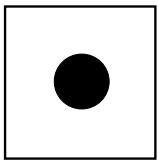

260 Operable

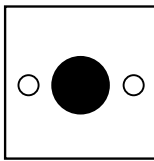

261 Operable



262 Blank

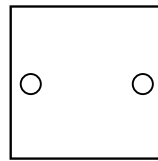

263 Blank

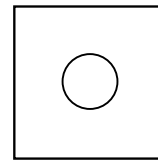

264 Fixed

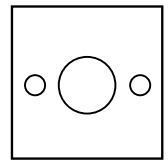

265 Fixed

Square Escutcheon Furniture 50 x 50mm

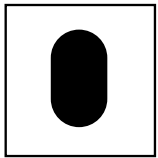

280SQ

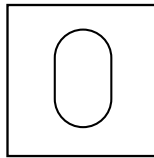

281SQ

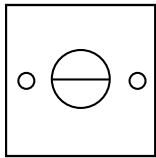

282SQ

Functions Legend

| | |
|----------------|--|
| Cylinder Hole | |
| Turnknob | |
| Emergency Turn | |

260 Series Ordering Procedure

Ordering Procedure

Sample part number 260/261/SQ96SS is made up of several sections. Choose your product by selecting an option from each section.

Half Set

For example:

| | | | |
|---------------|-------------|---------|--------|
| Exterior Rose | Lever/ Knob | Handing | Finish |
| 260 | SQ | 96 | SS |

Note: Choose one rose only, exterior or interior.

260 Series

| | | | | | |
|---------------|---------------|------------|-------------|---------|--------|
| Exterior Rose | Interior Rose | Rose Shape | Lever/ Knob | Handing | Finish |
| 260 | 261 | - | 96 | L | SS |

Exterior Rose Type

| | |
|---------------------------------|-----|
| Exterior Rose | 260 |
| Exterior Blank Rose | 262 |
| Exterior Round Rose -Fixed Rose | 264 |

Interior Rose Type

| | |
|---------------------|-----|
| Interior Rose | 261 |
| Interior Blank Rose | 263 |
| Interior Fixed Rose | 265 |

Rose Shape

| | |
|--------|----|
| Round | - |
| Square | SQ |

AS1428.1 Compliant Lever Types

| | | |
|-----|-----|-----|
| 102 | 111 | 112 |
| 115 | 116 | 118 |
| 124 | 131 | 132 |
| 133 | 142 | 144 |
| 145 | 155 | 166 |
| 47 | 59 | 70 |
| 74 | 76 | 77 |
| 90 | | |

Non compliant lever/knob types

| | | |
|-----|-----|-----|
| 101 | 104 | 123 |
| 178 | 41 | 97 |
| 20 | | |

Handed Levers

Brass Levers

| | |
|-----|-----|
| 122 | 153 |
|-----|-----|

* Levers 65 and 85 not available in PS or PB

Handing

| | |
|--------------|---|
| Left Handed | L |
| Right Handed | R |

Finish - 260 Series

| | |
|--------------------------|----|
| Satin Stainless Steel | SS |
| Powdercoat | PC |
| Polished Stainless Steel | PS |
| Aluminium | NT |
| Polished Brass | PB |

Finish - 260SQ Series

| | |
|-----------------------|----|
| Satin Stainless Steel | SS |
|-----------------------|----|

Velocity® Series Large Rose Door Furniture



The Velocity Series is a stylish range of door furniture suitable for use in residential dwellings.

Designed to suit common door preparations in the Australian market, Velocity is ideal for both new and retrofit applications.

Retrofitable

Fits majority of doors with 54mm hole.

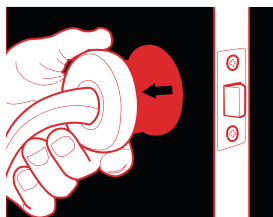

1 Align 2 Twist 3 Tighten



Features and Specifications

- All fixings are concealed beneath a removable rose trim providing a crisp and clean presentation desired by the discerning home owner
- Simple twist and tighten fixing method and lever set pre-assembly allows for super easy and super fast installation
- Available in a choice of six lever designs and three finishes
- The rose fits 50mm or 54mm diameter holes making it suitable for retrofit and common door preparations
- Designed in Australia for the specific needs of the Australian market

Product Details

Rose Dimensions 63mm by 12.5mm.

Materials All Velocity levers and roses are made from solid zinc die-cast with steel rose trims.

Latches Passage sets are available both with and without a 60mm backset tubular latch. Privacy sets are supplied with a 60mm backset privacy latch which includes an activating pin for the inside of the door and an external emergency release function. The latch is automatically released when the internal handle is operated and is easily adapted for both open in and open out applications. All latches are supplied with industry standard "D" strikes.

Door Thickness 32mm to 45mm hinged doors

Finishes Satin Chrome Brushed (SC)
Satin Chrome Pearl (SP)
Chrome Plate (CP)

Standards and Compliance

D8

VEL Series lever sets have been successfully tested to conform with Level D8 (500,000 cycles) under Australian Standard AS4145.2-2008, Locksets and hardware for doors and windows.



VEL Series in brushed satin chrome finish has been successfully tested to conform with Level C10 (1000 hours) under Australian Standard AS4145.2-2008, Locksets and hardware for doors and windows.

Not suited to coastal applications

Velocity® Series Large Rose Door Handles

Summit® – Lever 1

| | |
|-------------------------|--------|
| Length | 122mm |
| Projection | 56.5mm |
| Finger Clearance | 34.5mm |

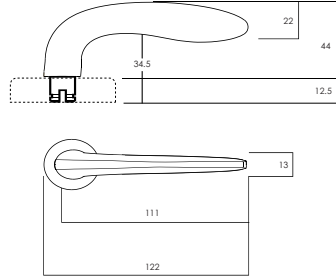

Spire® – Lever 2

| | |
|-------------------------|--------|
| Length | 124mm |
| Projection | 57.5mm |
| Finger Clearance | 44.5mm |

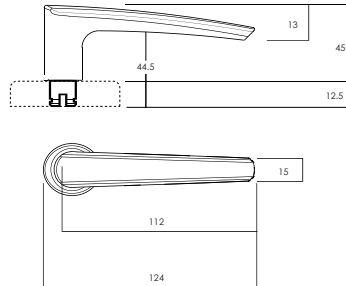

Element™ – Lever 3

| | |
|-------------------------|--------|
| Length | 122mm |
| Projection | 54.5mm |
| Finger Clearance | 47.5mm |

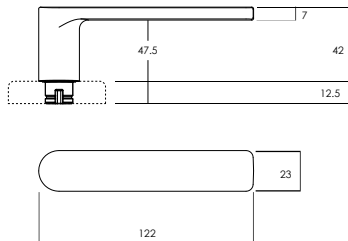

Glide™ – Lever 4

| | |
|-------------------------|--------|
| Length | 121mm |
| Projection | 56.5mm |
| Finger Clearance | 33.5mm |

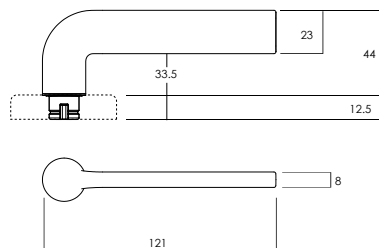

Velocity® Series Large Rose Door Handles

Hakea® - Lever 28

| | |
|-------------------------|-------|
| Length | 121mm |
| Projection | 63mm |
| Finger Clearance | 43mm |

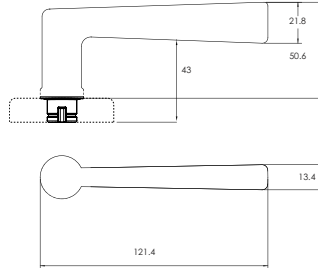

Saltbush® - Lever 34

| | |
|-------------------------|--------|
| Length | 120mm |
| Projection | 64mm |
| Finger Clearance | 43.5mm |

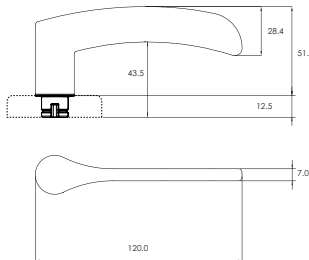

Velocity® Series Large Rose Accessories

Square Rose Passage Trim

| | |
|--------------------|-----------|
| Part Number | VES1-TRIM |
| Height | 65mm |
| Depth | 12.5mm |
| Quantity | Pack of 2 |

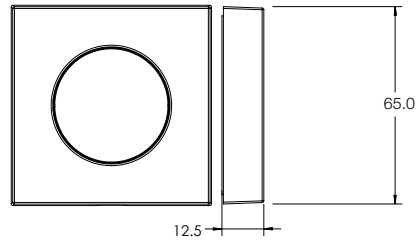

Square Rose Privacy Trim

| | |
|--------------------|-----------|
| Part Number | VES2-TRIM |
| Height | 65mm |
| Depth | 12.5mm |
| Quantity | Pack of 2 |

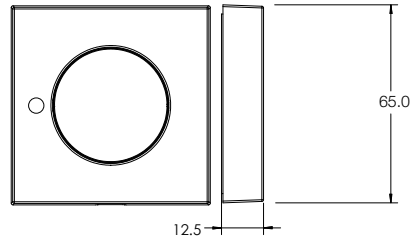

Velocity® Series Large Rose Ordering Procedure

Ordering Procedure

Sample part number VEL1/L1/SC is made up of several sections. Choose your product by selecting an option from each section.

Velocity® 63mm Series

| Exterior Rose | Function | Lever Type | Latch | Finish | Packaging |
|---------------|----------|------------|-------|--------|-----------|
| VEL | 1 | L1 | | SC | |

| Rose Type | Levers | Latch | Finish | Packaging |
|---------------------|--------------|----------------------------|---|------------|
| 63mm Round Rose VEL | Summit® L1 | No latch (Passage only) NL | Satin Chrome Brushed SC | Trade - |
| | Spire® L2 | | Satin Chrome Pearl SP | Display DP |
| | Element™ L3 | | Chrome Plate CP | |
| | Glide™ L4 | | Matt Black MBK* | |
| | Hakea® 28 | | *MBK finish on Velocity Large Rose is only available with Lever 3 | |
| | Saltbush® 34 | | | |

| Function | |
|------------|---|
| Passage | 1 |
| Privacy | 2 |
| Dummy Half | 3 |

Square Rose Ordering Procedure

| Function | Satin Chrome Finish | Chrome Plate Finish | Satin Pearl Finish | Matt Black Finish |
|-------------------------------------|---------------------|---------------------|--------------------|-------------------|
| Passage Lever Set Dummy Half Set | VES1-TRIMSC | VES1-TRIMCP | VES1-TRIMSP | VES1-TRIMMBK |
| Privacy Lever Set | VES2-TRIMSC | VES2-TRIMCP | VES2-TRIMSP | VES2TRIM-MBK |

Square Rose Lever Sets are ordered in the same manner as Round Rose Lever Sets above with the addition of a Square Rose Trim Pack. For example a Passage Lever Set, Lever 4 in Satin Chrome will require both VEL1/L4SC and VES1-TRIMSC.

Velocity® Series Small Rose Door Handles



The Velocity 55mm Series is a stylish range of door furniture suitable for both residential and semi commercial applications. Designed primarily for new installation on timber doors, the range incorporates functionality for use with Mortice Locks in addition to Passage, Privacy and Dummy Levers.

Installation

Suits door preparations up to 45mm.

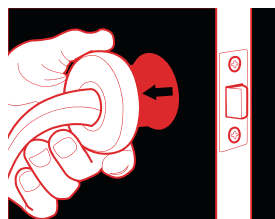

1 Align **2 Twist** **3 Tighten**



Features and Specifications

- All fixings are concealed beneath a removable rose trim providing an aesthetically appealing installation.
- Simple twist and tighten fixing method and pre-assembled lever sets allow for super easy and fast installation.
- Lever range includes two AS1428.1 compliant levers and six designer levers.
- Accessories include AS1428.1 compliant turn, standard turn and privacy indicating emergency turns.
- The 55mm rose suits up to 45mm door preparations commonly used with mortice locks or latches.
- Designed in Australia for the specific needs of the Australian market.

Product Details

| | |
|------------------------|---|
| Rose Dimensions | 55mm by 12.5mm - Round Rose 58mm by 12.5mm - Square Rose |
| Materials | All Velocity 55mm levers and roses are made from solid zinc die-cast. |
| Latches | Passage sets are available with a 60mm backset tubular latch. Privacy sets are supplied with a 60mm backset privacy latch which includes a locking pin for the inside of the door and an external emergency release function. The latch is automatically released when the internal handle is operated and is easily adapted for both open in and open out applications. All latches are supplied with industry standard "D" strikes. |
| Door Thickness | 32mm to 45mm hinged doors |
| Finishes | Satin Chrome Brushed (SC) Chrome Plate (CP) Satin Pearl (SP) Display Pack Range Only |

Standards and Compliance



Successfully tested up to 2 hours on fire door assemblies in accordance with the Australian Standard AS1905.1 2005 - Part 1: Fire Resistant Doorsets

D8

VEL Series lever sets have been successfully tested to conform with Level D8 (500,000 cycles) under Australian Standard AS4145.2-2008, Locksets and hardware for doors and windows.



VEL Series in brushed satin chrome finish has been successfully tested to conform with Level C10 (1000 hours) under Australian Standard AS4145.2-2008, Locksets and hardware for doors and windows.



AS1428.1 Compliance. The range includes AS1428.1 compliant levers and turns as shown.

Velocity® Series Small Rose Door Handles

AS1428.1 Compliant Levers

Accession® - Lever 5

Length 121mm

Projection 56.5mm

Finger Clearance 38.4mm



Disabled Accessible
AS1428.1

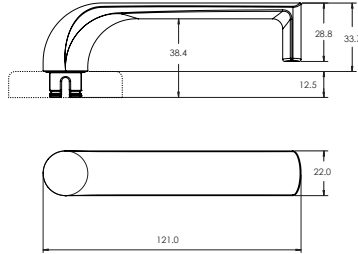

Dianella™ - Lever 8

Length 121mm

Projection 51mm

Finger Clearance 38mm



Disabled Accessible
AS1428.1

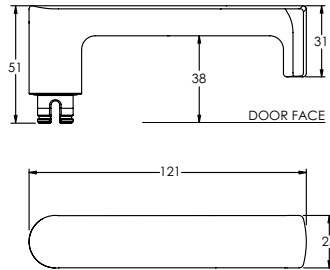

Gidgee® - Lever 37

Length 120mm

Projection 64mm

Finger Clearance 38.5mm



Disabled Accessible
AS1428.1

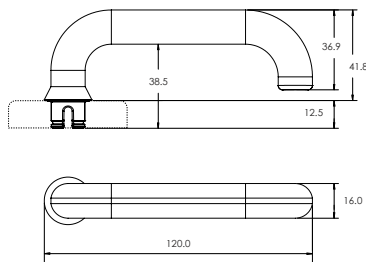

Standard Levers

Element™ - Lever 3

Length 122mm

Projection 54.5mm

Finger Clearance 47.5mm

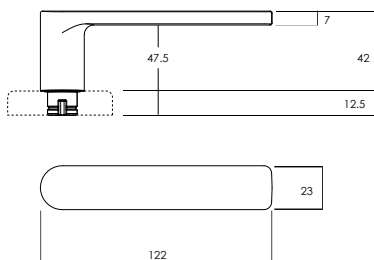

Velocity® Series Small Rose Door Handles

Standard Levers

Hakea® - Lever 28

| | |
|-------------------------|-------|
| Length | 121mm |
| Projection | 63mm |
| Finger Clearance | 43mm |

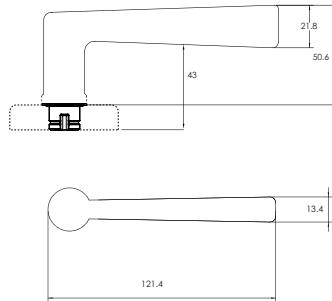

Acacia® - Lever 29A

| | |
|-------------------------|--------|
| Length | 120mm |
| Projection | 64mm |
| Finger Clearance | 41.5mm |

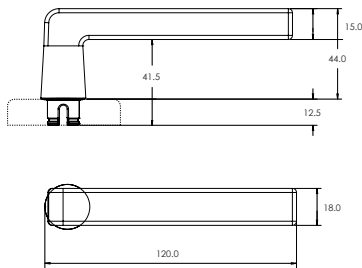

Saltbush® - Lever 34

| | |
|-------------------------|--------|
| Length | 120mm |
| Projection | 64mm |
| Finger Clearance | 43.5mm |

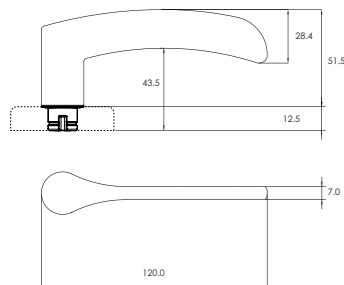

Velocity® Series Small Round Rose Accessories

Euro Cylinder Escutcheon

| | |
|--------------------|--------|
| Part Number | VSR5 |
| Height | 55mm |
| Depth | 12.5mm |

Supplied with
2x Wood Screws

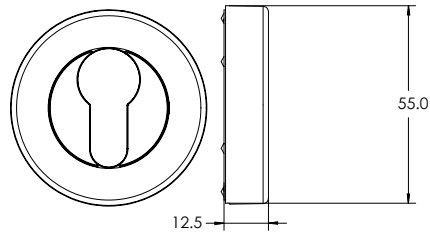

Oval Cylinder Escutcheon

| | |
|--------------------|--------|
| Part Number | VSR6 |
| Height | 55mm |
| Depth | 12.5mm |

Supplied with
2x Wood Screws

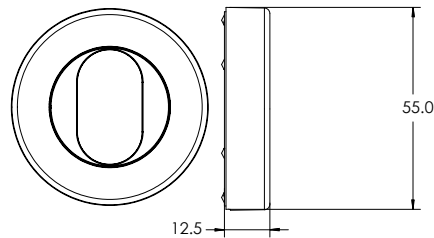

Standard Turnknob

| | |
|--------------------|--------------|
| Part Number | VSR7 |
| Height | 55mm |
| Depth | 12.5mm |
| Handing | Not required |

Supplied with
2x Wood Screws
1x Short Tail Bar
1x Medium Tail Bar
1x Tail Bar Spring
1x Instructions (1220-321)

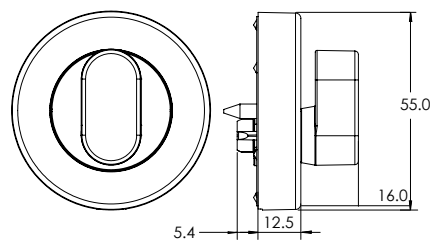

Privacy Indicating Emergency Turn

| | |
|--------------------|--------|
| Part Number | VSR8 |
| Height | 55mm |
| Depth | 12.5mm |

Supplied with
2x Wood Screws
1x Emergency Tail Bar
1x Instructions (1220-321)

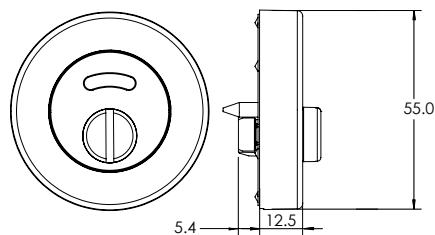

Velocity® Series Small Round Rose Accessories

Disabled Accessible Turnknob

| | |
|-------------------------|---------------|
| Part Number | VSR9 |
| Height | 55mm |
| Depth | 12.5mm |
| Turn Snib Length | 52mm |
| Handing | Site handable |

Supplied with

- 2x Wood Screws
- 1x Tail Bar (short)
- 1x Tail Bar (medium)
- 1x Tail Bar Spring
- 1x Instructions (1220-321)

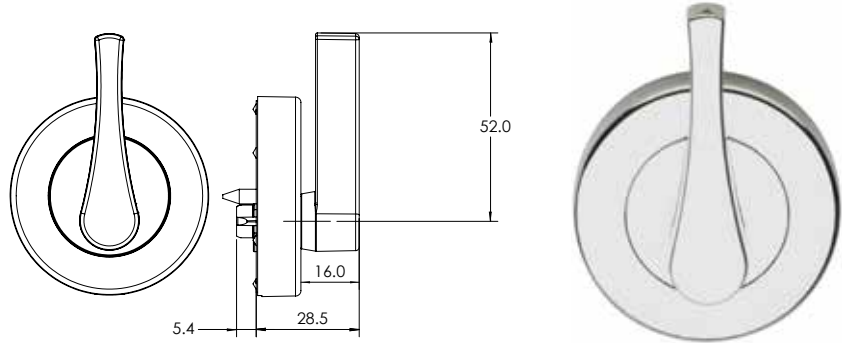

*VSR9 is not compatible with Selector series mortice locks.

Round Rose Passage Trim

| | |
|--------------------|-----------|
| Part Number | VSR1-TRIM |
| Height | 55mm |
| Depth | 12.5mm |
| Quantity | Pack of 2 |

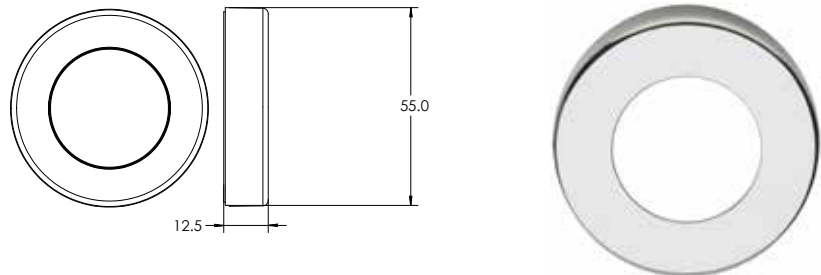

Round Rose Privacy Trim

| | |
|--------------------|-----------|
| Part Number | VSR2-TRIM |
| Height | 55mm |
| Depth | 12.5mm |
| Quantity | Pack of 2 |

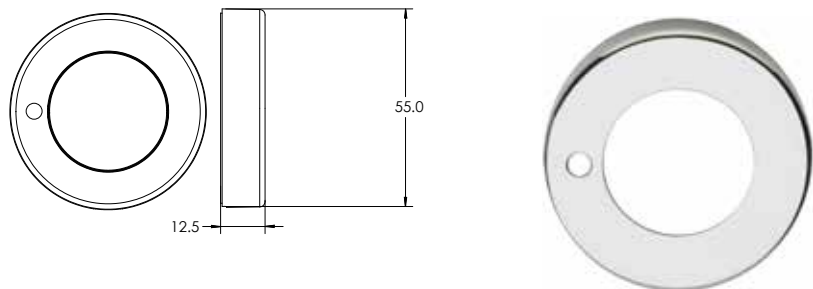

Velocity® Series Small Square Rose Accessories

Euro Cylinder Escutcheon

| | |
|--------------------|--------|
| Part Number | VSS5 |
| Height | 58mm |
| Depth | 12.5mm |

Supplied with
2x Wood Screws

Note: Please ensure clearance between lever trim and escutcheons when used with European Mortice Locks.

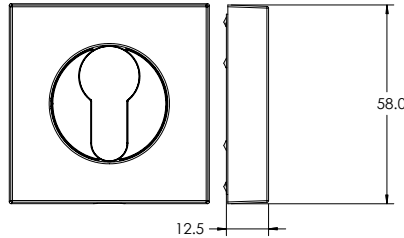

Oval Cylinder Escutcheon

| | |
|--------------------|--------|
| Part Number | VSS6 |
| Height | 58mm |
| Depth | 12.5mm |

Supplied with
2x Wood Screws

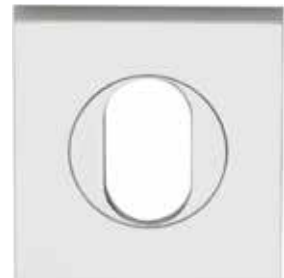
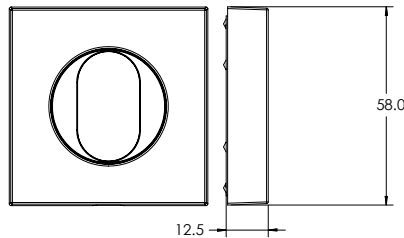

Standard Turn Snib

| | |
|--------------------|--------------|
| Part Number | VSS7 |
| Height | 58mm |
| Depth | 12.5mm |
| Handing | Not required |

Supplied with
2x Wood Screws
1x Short Tail Bar
1x Medium Tail Bar
1x Tail Bar Spring
1x Instructions (1220-321)

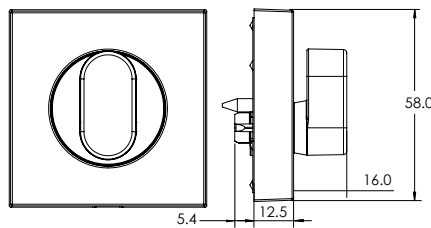

Emergency Indicating Turn

| | |
|--------------------|--------------|
| Part Number | VSS8 |
| Height | 58mm |
| Depth | 12.5mm |
| Handing | Not required |

Supplied with
2x Wood Screws
1x Emergency Tail Bar
1x Instructions (1220-321)

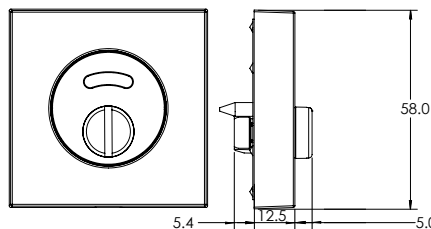

Velocity® Series Small Square Rose Accessories

Disabled Accessible Turn Snib

| | |
|-------------------------|---------------|
| Part Number | VSS9 |
| Height | 58mm |
| Depth | 12.5mm |
| Turn Snib Length | 52mm |
| Handing | Site handable |

Supplied with

- 2x Wood Screws
- 1x Tail Bar (short)
- 1x Tail Bar (medium)
- 1x Tail Bar Spring
- 1x Instructions (1220-321)

*VSS9 is not compatible with Selector series mortice locks.

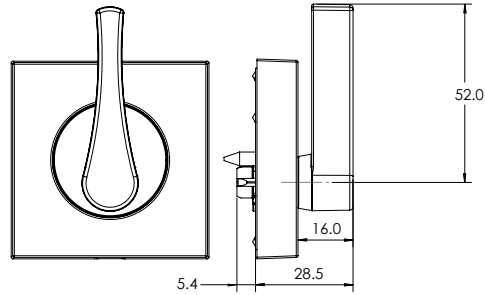

Square Rose Passage Trim

| | |
|--------------------|-----------|
| Part Number | VSS1-TRIM |
| Height | 58mm |
| Depth | 12.5mm |
| Quantity | Pack of 2 |

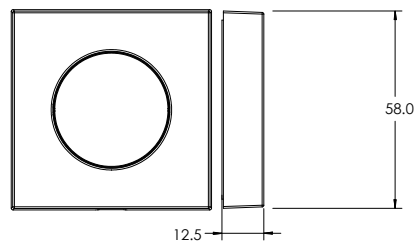

Square Rose Privacy Trim

| | |
|--------------------|-----------|
| Part Number | VSS2-TRIM |
| Height | 58mm |
| Depth | 12.5mm |
| Quantity | Pack of 2 |

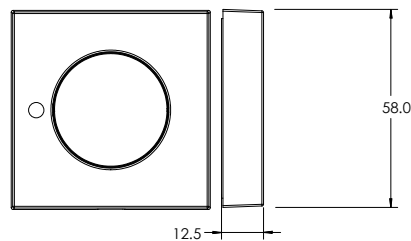

Velocity® Series Rose Door Handles

Sample part number VSR1/L3SC is made up of several sections. Choose your product by selecting an option from each section.

Velocity® Small Rose Series - Trade Pack Range

| Exterior Rose | Function | Lever Types | Finish | | | | |
|---------------------------|-------------------------------------|---------------------------|-------------------------|------------|--|--|--|
| VSR | 1 | L3 | SC | | | | |
| Rose Type | Function | Levers | Finish | Packaging | | | |
| Velocity 55mm Round Rose | Mortice 0 | Summit® L1 | Satin Chrome Brushed SC | Trade Pack | | | |
| Velocity 58mm Square Rose | Passage 1 | Element™ L3 | Chrome Plate CP | | | | |
| | Privacy 2 | Glide™ L4 | Matt Black MBK | | | | |
| | Dummy Half 3 | Hakea® 28 | | | | | |
| | Euro Escutcheon 5 | Acacia® 29A | | | | | |
| | Oval Escutcheon 6 | Saltbush® 34 | | | | | |
| | Standard Turnknob 7 | AS1428.1 Compliant Levers | | | | | |
| | Privacy Indicating Emergency Turn 8 | Accession® L5 | | | | | |
| | Disabled Accessible Turnknob 9 | Dianella™ L8 | | | | | |
| | | Gidgee® 37 | | | | | |

Note: Mortice, Passage, Privacy and Dummy Half Lever Sets only available in Round Rose. See below for ordering procedure

Velocity® Small Rose Series - Display Pack Range

| Rose Type | Function | Lever Types | Finish | Packaging | | |
|--------------------------|-----------|-------------|-------------------------|-----------|----|--|
| VSR | 1 | L3 | SC | DP | | |
| Rose Type | Function | Levers | Finish | Packaging | | |
| Velocity 55mm Round Rose | Passage 1 | Summit® L1 | Satin Chrome Pearl SP | Display | DP | |
| | Privacy 2 | Spire® L2 | Chrome Plate CP | | | |
| | | Element™ L3 | Satin Chrome Brushed SC | | | |
| | | Glide™ L4 | | | | |

Square Rose Ordering Procedure

| Function | Satin Chrome Finish | Chrome Plate Finish | Satin Pearl Finish | Matt Black Finish |
|-------------------|---------------------|---------------------|--------------------|-------------------|
| Mortice Lever Set | | | | |
| Passage Lever Set | VSS1-TRIMSC | VSS1-TRIMCP | VSS1-TRIMSP | VSS1-TRIMMBK |
| Dummy Half Set | | | | |
| Privacy Lever Set | VSS2-TRIMSC | VSS2-TRIMCP | VSS2-TRIMSP | VSS2-TRIMMBK |

Square Rose Lever Sets are ordered in the same manner as Round Rose Lever Sets above with the addition of a Square Rose Trim Pack. For example a Mortice Lever Set, Lever 5 in Satin Chrome will require both VSR0/L5SC and VSS1-TRIMSC.

Metal Finishes

For Metal Finish sample refer to code under each image.



Antique Copper (AC)
Sample Code: FIN-SAMPLEAC*



Architectural Bronze Unlacquered (AU)
Sample Code: FIN-SAMPLEAU*



Oil Rubbed Bronze (ORB)
Sample Code: FIN-SAMPLEORB*



Aged Brass (AG)
Sample Code: FIN-SAMPLEAG*

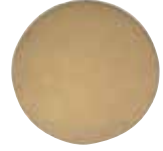

Architectural Bronze (AZ)
Sample Code: FIN-SAMPLEAZ**



Polished Brass (PB)
Sample Code: FIN-SAMPLEPB**



Satin Brass (SB)
Sample Code: FIN-SAMPLESB**



Polished Brass Unlacquered (BU)
Sample Code: FIN-SAMPLEBU*



Satin Brass Unlacquered (SBU)
Sample Code: FIN-SAMPLESBU*



Satin Chrome Plating (SC)
Sample Code: FIN-SAMPLESC



Chrome Plating (CP)
Sample Code: FIN-SAMPLECP



Stainless Steel (SS)
Sample Code: FIN-SAMPLESS



Polished Stainless Steel (PS)
Sample Code: FIN-SAMPLEPS



Natural Anodized Aluminium (NT)
Sample Code: FIN-SAMPLENT

NOTE: Not all decorative finishes apply to every Lockwood product. Refer to the table at the end of this document for specific decorative finishes applicable per series.

*Unlacquered Metal Finish. This finish will naturally age and its appearance will change over time according to the environment and use it is exposed to. For more information on the aging effect of a particular finish contact your ASSA ABLOY representative.

**Finish is protected by a top clear lacquer.

Disclaimer: Product Colours displayed in this catalogue have been matched to indoor viewing and colour appearance may vary according to light source and medium and as such should be used as indicative only. As actual colour on the end product may vary, always confirm your colour choice with production line prepared samples from your ASSA ABLOY representative for final colour approval. For warranty terms and conditions on Lockwood Products and its finishes, please visit www.lockweb.com.au or call 1300WARRANTY

Dulux Powdercoat Finishes

For Powdercoat Finish sample order code:

FIN-SAMPLEPC specify the desired color from the images below when placing order.

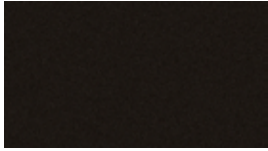

Dulux Duratec Eternity
Eternity Charcoal Pearl
Satin



Dulux Electro
Black Ace
Flat



Dulux Electro
Dark Bronze
Flat



Dulux Electro
Medium Bronze
Flat

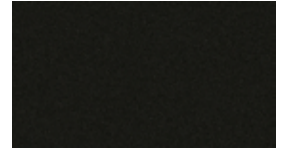

Dulux Precious
Charcoal Metallic Pearl
Gloss



Dulux Precious
Citi Pearl
Matt



Dulux Precious
Natural Pearl
Matt



Dulux Precious
Nickel Pearl
Matt



Dulux Precious
Sharp Silver Kinetic® Pearl
Satin



Dulux Precious
Silver Kinetic® Pearl
Satin

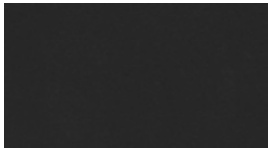

Dulux Surreal Effects Mannex
Mannex Black
Effect



Dulux Surreal Effects Scylla
Red Brown Scylla
Effect

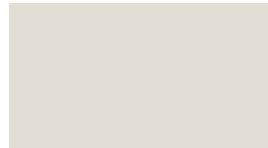

Dulux Duralloy
Shoji White
Satin

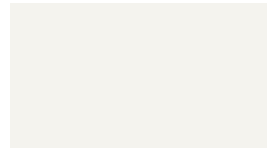

Dulux Alphatec
White
Matt

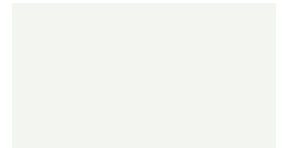

Dulux Duralloy
White
Satin



Dulux Duralloy
Black
Gloss



Dulux Duralloy
Monument®
Satin

CB



Dulux Duralloy
Black (C/B Night Sky®)
Satin

CB



Dulux Duralloy
Dune®
Satin

CB



Dulux Duralloy
Woodland Grey®
Satin

CB

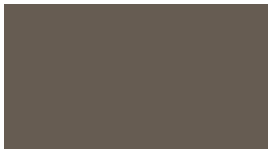

Dulux Duralloy
Jasper®
Satin

CB



Dulux Duralloy
Monument®
Matt

CB



Dulux Duralloy
Deep Ocean®
Satin

CB



Dulux Duralloy
Woodland Grey®
Matt

CB



Dulux Duralloy
APO Grey
Satin

NOTE: Not all Powdercoat Finishes apply to every Lockwood product. Refer to the notes at the end of this document for specific decorative finishes applicable per series.

CB Colorbond and the Colorbond colour names are registered trademarks of Bluescope Steel Limited



We recommend and use Dulux Powders

Disclaimer: Dulux, Duralloy, Anotec, Silver Kinetic, are registered trade marks of DuluxGroup (Australia) Pty Ltd. Monument, Night Sky, Dune, Woodland Grey, Jasper, Deep Ocean, Surfist, Pale Eucalypt, Paperbark, are registered trademarks of Bluescope Steel Limited. Product Colours displayed in this catalogue have been matched to indoor viewing and colour appearance may vary according to light source and medium and as such should be used as indicative only. As actual colour on the end product may vary, always confirm your colour choice with production line prepared samples from your ASSA ABLOY representative for final colour approval. For warranty terms and conditions on Lockwood Products and its finishes, please visit www.lockweb.com.au or call 1300WARRANTY



Dulux Powdercoat Finishes

For Powdercoat Finish sample order code:

FIN-SAMPLEPC specify the desired color from the images below when placing order.

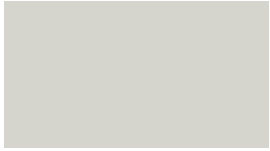

Dulux Duralloy
Surfmist®
Matt

CB

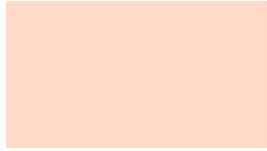

Dulux Duralloy
Anotec® Off White
Matt



Dulux Duralloy
Anotec® Mid Bronze
Matt



Dulux Duralloy
Dune®
Matt

CB



Dulux Duralloy
Anotec® Dark Grey
Matt

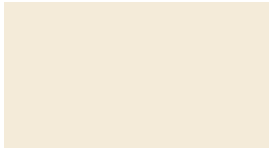

Dulux Duralloy
White Birch
Gloss



Dulux Duralloy
Stone Beige
Matt



Dulux Duralloy
Notre Dame
Gloss



Dulux Duralloy
Pale Eucalypt®
Satin

CB



Dulux Duralloy
Magnolia
Gloss



Dulux Duralloy
Doeskin
Satin



Dulux Duralloy
Paperbark®
Satin

CB



Dulux Duralloy
Classic Hawthorn Green
Gloss



Dulux Duralloy
Primrose
Gloss



Dulux Duralloy
Black (C/B Night Sky®)
Matt

CB

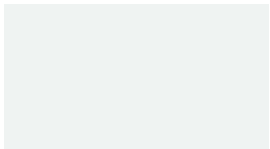

Dulux Duralloy
Pearl White
Gloss

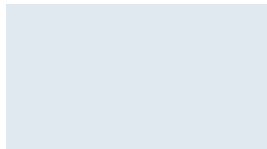

Dulux Duralloy
Bright White
Gloss



Dulux Precious
Mahogany Gloss Pearl



Dulux Surreal Effects
Black Gold
Gloss



Dulux Duralloy
Charcoal Lustre
Matt



Dulux Alphatec
Ranch Brown
Satin

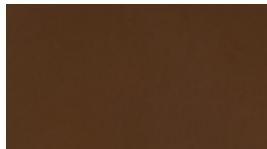

Dulux Duralloy
Coffee
Satin

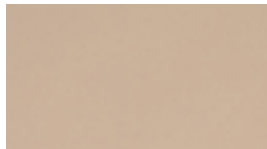

Dulux Duralloy
Pottery
Satin

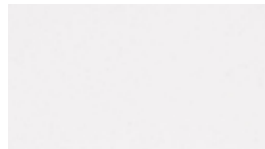

Dulux Duralloy
White Lustre
Matt

NOTE: Not all Powdercoat Finishes apply to every Lockwood product. Refer to the notes at the end of this document for specific decorative finishes applicable per series.

CB Colorbond and the Colorbond colour names are registered trademarks of Bluescope Steel Limited



We recommend and use Dulux Powders

Disclaimer: Dulux, Duralloy, Anotec, Silver Kinetic, are registered trade marks of DuluxGroup (Australia) Pty Ltd. Monument, Night Sky, Dune, Woodland Grey, Jasper, Deep Ocean, Surfist, Pale Eucalypt, Paperbark, are registered trademarks of Bluescope Steel Limited. Product Colours displayed in this catalogue have been matched to indoor viewing and colour appearance may vary according to light source and medium and as such should be used as indicative only. As actual colour on the end product may vary, always confirm your colour choice with production line prepared samples from your ASSA ABLOY representative for final colour approval. For warranty terms and conditions on Lockwood Products and its finishes, please visit www.lockweb.com.au or call 1300WARRANTY

Decorative Finishes Per Series

Powdercoat Finishes

Rose Door Handles: Robert Watson, 1220, 1420, 1360, 1370, 260, 260SQ

Plate Door Handles: 1800, 2800, 4800, 5800, 200, 202, 212, 224

Push/Pull Plates: 218/219, 206/207, 208/209, 214/215, 216/217, 184, 185

Metal Finishes

Use table below as a reference for the applicable finish to each Lockwood Series.

Refer to the series catalogue for specific detailed information.

| Reference Table | | | | | | | | | |
|---------------------------------------|--|---|--|--|---|--|------------------------------------|---|--|
| | Brass Series Rose Door Handles 1220, 1420, 1360, 1370 | Brass Series Plate Door Handles 1800, 2800, 4800, 5800 | Artefact Series Rose Door Handles 260 | Artefact Series Rose Door Handles 260SQ | Artefact Series Plate Door Handles 200, 202, | Artefact Series Plate Door Handles 212, 224 | Push/Pull Plate Series 184, 185 | Push/Pull Plate Series 214/215, 216/217, 218/219 | Push/Pull Plate Series 206/207, 208/209 |
| Antique Copper (AC) | ✓ | ✓ | ✓ | ✗ | ✓ | ✗ | ✓ | ✓ | ✗ |
| Architectural Bronze Unlacquered (AU) | ✓ | ✓ | ✓ | ✗ | ✓ | ✗ | ✓ | ✓ | ✗ |
| Oil Rubbed Bronze (ORB) | ✓ | ✓ | ✓ | ✗ | ✓ | ✗ | ✓ | ✓ | ✗ |
| Aged Brass (AG) | ✓ | ✓ | ✓ | ✗ | ✓ | ✗ | ✓ | ✓ | ✗ |
| Architectural Bronze (AZ) | ✓ | ✓ | ✓ | ✗ | ✓ | ✗ | ✓ | ✓ | ✗ |
| Polished Brass (PB) | ✓ | ✓ | ✓ | ✗ | ✓ | ✗ | ✓ | ✓ | ✗ |
| Satin Brass (SB) | ✓ | ✓ | ✓ | ✗ | ✓ | ✗ | ✓ | ✓ | ✗ |
| Polished Brass Unlacquered (BU) | ✓ | ✓ | ✓ | ✗ | ✓ | ✗ | ✓ | ✓ | ✗ |
| Satin Brass Unlacquered (SBU) | ✓ | ✓ | ✓ | ✗ | ✓ | ✗ | ✓ | ✓ | ✗ |
| Satin Chrome Plating (SC) | ✓ | ✓ | ✗ | ✗ | ✗ | ✗ | ✓ | ✗ | ✗ |
| Chrome Plating (CP) | ✓ | ✓ | ✗ | ✗ | ✗ | ✗ | ✓ | ✗ | ✗ |
| Stainless Steel (SS) | ✗ | ✗ | ✓ | ✓ | ✓ | ✓ | ✗ | ✓ | ✓ |
| Polished Stainless Steel (PS) | ✗ | ✗ | ✓ | ✗ | ✓ | ✓ | ✗ | ✓ | ✓ |
| Marine Grade Stainless Steel (MG) | ✗ | ✗ | ✓ | ✗ | ✓ | ✓ | ✗ | ✓ | ✓ |
| Natural Anodised Aluminium (NT) | ✗ | ✗ | ✓ | ✗ | ✓ | ✓ | ✗ | ✗ | ✗ |

Disclaimer: Product Colours displayed in this catalogue have been matched to indoor viewing and colour appearance may vary according to light source and medium and as such should be used as indicative only. As actual colour on the end product may vary, always confirm your colour choice with production line prepared samples from your ASSA ABLOY representative for final colour approval. For warranty terms and conditions on Lockwood Products and its finishes, please visit www.lockweb.com.au or call 1300WARRANTY



ASSA ABLOY

Lockwood is the leading brand in the Australian locking industry. With an established reputation for high quality products, this iconic brand provides a wide range of locking solutions to residential housing, commercial, semi-commercial, building and industrial application markets. Lockwood is supported by an extensive distribution and after-sales support network. Our customers include retailers, architects, trade and industrial personnel, locksmiths and security dealers.

ASSA ABLOY is the global leader in door opening solutions, dedicated to satisfying end-user needs for security, safety and convenience.

ASSA ABLOY is represented in all major regions, in both mature and emerging markets, with leading positions in Australia, Europe and North America.

**25YEAR
MECHANICAL
WARRANTY**

The Lockwood 25 Year Mechanical Warranty

Our belief that we manufacture the finest premium products available in today's market place is backed by the Lockwood 25 Year Mechanical Warranty, ensuring that Lockwood continues to keep Australians safe by delivering security and peace of mind.

For warranty terms and conditions, please visit www.lockweb.com.au or call **1300WARRANTY**

ASSA ABLOY Opening Solutions Australia
235 Huntingdale Road
Oakleigh, Victoria, 3166
Australia

1300 LOCK UP (1300 562 587)
lockweb.com.au

ASSA ABLOY New Zealand Ltd
6 Armstrong Road
Albany, Auckland, 0632
New Zealand

nzsales@assaabloy.com
Telephone +64 9415 7111
assaabloyopeningsolutions.nz

Disclaimer

Whilst every effort has been made to ensure that the information (including product images and drawings) contained in this brochure is accurate at the time of publication, ASSA ABLOY Australia Pty Limited ("ASSA ABLOY") recommends that you consult ASSA ABLOY or its agents prior to placing an order to ascertain current information on specific products, as ASSA ABLOY reserves the right to make changes without notice. ASSA ABLOY will not be liable for any injury, loss or damage whatsoever, arising from any errors or omissions in the information contained in the brochure or arising from the use or application of the information contained herein. © 2019 copyright by ASSA ABLOY All rights reserved

