

Rose Door Handles



We take the worry out of
protecting what's valuable to you.
Lockwood: *no worries*[®]

LOCKWOOD

ASSA ABLOY

25YEAR MECHANICAL
WARRANTY

www.lockweb.com.au

Contents



Robert Watson Series

Door Handles and Accessories

page 3



1220 Symphony Series

Round Rose Door Handles

page 12



1420 Symphony Series

Square Rose Door Handles

page 32



1360 Series

Round Rose Door Handles

page 52



1370 Series

Round Rose Door Handles

page 71



260 Artefact Series

Round Rose Door Handles

page 90



260SQ Series

Square Rose Door Handles

page 92



Velocity® Series

Large Rose Door Furniture

page 95



Velocity® Series

Small Rose Door Handles

page 100



Vivid® Collection

Internal Door Leversets

page 108



Finishes

page 114

Robert Watson Series Door Handles



The Robert Watson Collection of door furniture consists of three lever designs and a range of complementing escutcheons, turnknobs and emergency release sets. The roseless design of the furniture is unprecedented and the innovation and lateral thinking involved in the development of the products has led to them being patent protected and design registered.

Application

The Robert Watson range is suitable for commercial as well as residential use.

It can be fitted with:

- Lockwood Selector 3770 Series Mortice Locks
- Lockwood Synergy 3570 Series Mortice Locks
- Lockwood 6780 and 6580 Mortice Locks (38mm backset, metal doors only)
- Lockwood 531 Latches and 6260 Tubular Bolts

Fixing

Furniture is fixed to Selector 3770 or Synergy 3570 Series Mortice Locks using a specially developed pair of steel adaptor plates that are secured through the lock case using screws.

Robert Watson furniture may also be fitted with a Lockwood 531 Latch using a steel adaptor which locates over the body of the latch.

A special adaptor for fixing Robert Watson furniture to 6780 and 6580 Narrow Style Mortice Locks in hollow aluminium door sections is also available.

Product Details

Dimensions	Body: 36mm diameter. Projection from door: 62.5mm.
Materials	Furniture body: aluminium. Mounting stock and other internal components: stainless steel, steel and brass.
Door Thickness	Selector 3770 and Synergy 3570 Series: 32mm to 50mm Selector 6780 and Synergy 6580 Series: 32mm to 50mm Lockwood 531 Latches: 35mm to 50mm For Mortice Lock installation on doors 51mm to 62mm thick, use accessory pack RW00-42.
Finishes	Satin Anodised (SA) Powdercoat (PC)

Standards and Compliance



Robert Watson Series has been successfully tested up to 4 hours with a fire rated Lockwood mortice lock on fire door assemblies (depending on type of doorset) in accordance with Australian Standard AS1905.1:2005, Fire Resistant Doorsets

D8

Robert Watson Series lever sets have been successfully tested to conform with Level D8 (500,000 cycles) under Australian Standard AS4145.2-2008, Locksets and hardware for doors and windows



Robert Watson Series in satin anodised finish has been successfully tested to conform with Level C10 (1000 hours) under Australian Standard AS4145.2-2008, Locksets and hardware for doors and windows

Robert Watson Series is designed, assembled and customised in Australia to suit the requirements of the Australian Market

Robert Watson Levers

Tangent - Lever A1

Length	143 mm
Projection	62.5 mm
Finger Clearance	44.5 mm

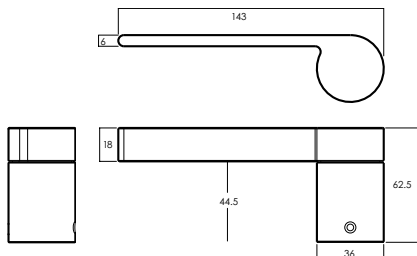

Centre - Lever A2

Length	143 mm
Projection	62.5 mm
Finger Clearance	44.5 mm

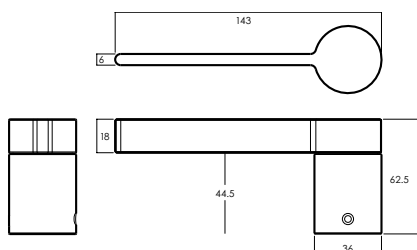

Centre D - Lever A3

Length	143 mm
Projection	62.5 mm
Finger Clearance	44.5 mm

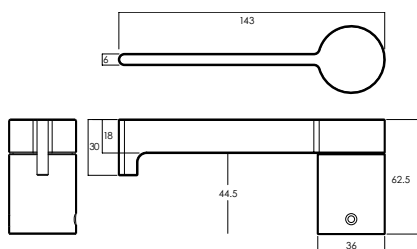

Robert Watson Series Escutcheons



These escutcheons are designed to be fitted with Lockwood oval cylinders and the Robert Watson range of turnknobs and emergency turns. Fitted using a grub screw, they ensure that the accessories they are fitted with are aesthetically pleasing.

Use with Lockwood Mortice Locks and 6260 Bolts. The escutcheons are available in different sizes for suitability to different door thicknesses.

Note: Escutcheons must be ordered separately for use with oval cylinders, turnknobs and emergency release turns.

Escutcheons

Part Numbers	Door Thickness	(A) Dimension
RW06/38	35–38mm thick	17mm
RW06/44	39–44mm thick	14mm
RW06/50	45–50mm thick	11mm
RW06/56	51–56mm thick*	8mm
RW06/62	57–62mm thick*	5mm

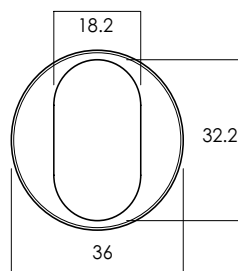

*Extended door accessory pack required if levers are to be installed on doors of this thickness.

Robert Watson Series Accessories

Turnknob

Part Number RW07

*Accessories—use with Selector 3770 and 6780 Series or Synergy 3570 and 6580 Series Mortice Locks.

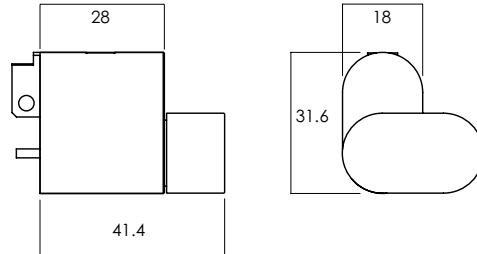

Privacy Indicating Turnknob

Part Number RW08

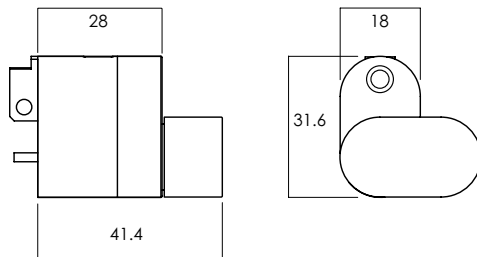

Turnknob and Emergency Release Set

Part Number RW09

*Accessories—use with Selector 3770 and 6780 Series or Synergy 3570 and 6580 Series Mortice Locks.

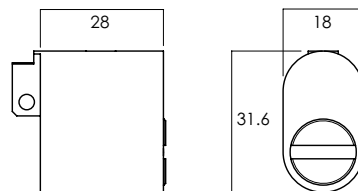

Exterior

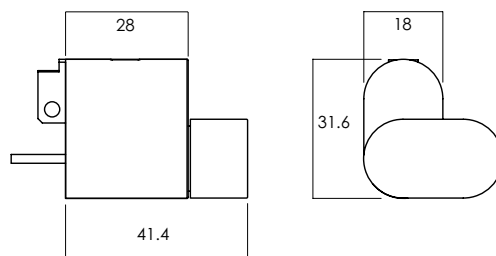

Interior

Robert Watson Series Accessories

Turnknob and Privacy Indicating Emergency Release Set

Part Number RW10

*Accessories—use with Selector 3770 and 6780 Series or Synergy 3570 and 6580 Series Mortice Locks.

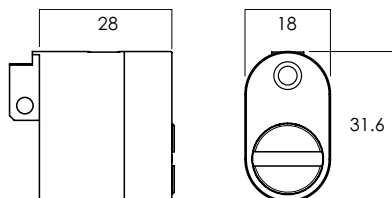

Exterior

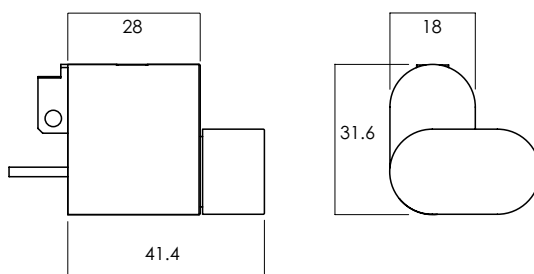

Interior

Privacy Indicating Turnknob and Privacy Indicating Emergency Release Set

Part Number RW11

*Accessories—use with Selector 3770 and 6780 Series or Synergy 3570 and 6580 Series Mortice Locks.

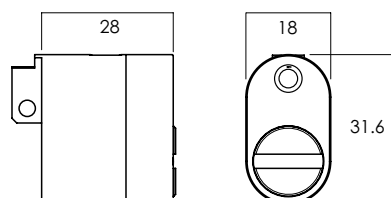

Exterior

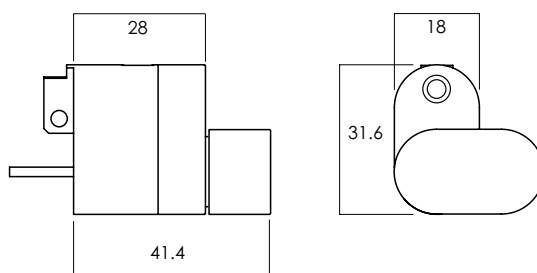

Interior

Robert Watson Series Accessories

Turnknob and Emergency Release Set

Part Number RW13

*Accessories—use with Lockwood 6260 Tubular Bolt.

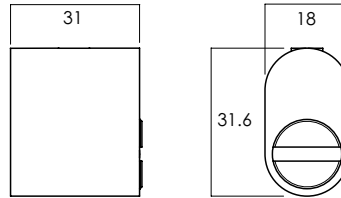

Exterior

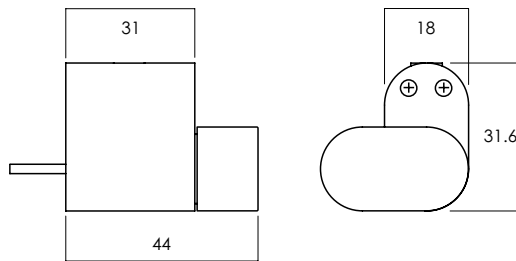

Interior

Privacy Indicating Emergency Release

Part Number RW14

*Accessories—use with Selector 3770 and 6780 Series or Synergy 3570 and 6580 Series Mortice Locks.

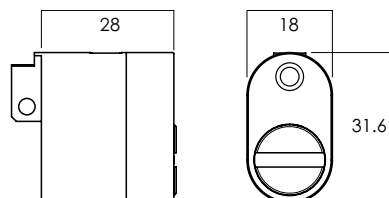

Exterior

Accessories—Latch Kits

Part Numbers (Backset) Dimension

RW531/60SC 60mm

RW531/70SC 70mm

RW531/127SC 127mm

*Latch kits are supplied with adaptors required to fit Robert Watson Levers.



Robert Watson Series Accessories

Standard turn adaptors supplied with Selector 3770 Series Mortice Locks can be used with Robert Watson turnknobs, no special adaptors needed. Simply remove the plastic insert of the turn adaptors during installation. Refer to the list below for Selector Series turn adaptors.

Selector 3770 Series Mortice Lock Turn Adaptors

Function	Adaptor
Locking Function	3772-ADAPTOR
Latching Function	3770-ADAPTOR



Special adaptors are required when using Robert Watson turnknobs with Synergy Series Mortice Locks. These can be ordered as spare parts. Refer to the list below.

Synergy 3570 Series Mortice Lock Turn Adaptors

Function	Adaptor	Function	Adaptor
3570XTR	SP3570-6050	3572WTR	SP3572-6250
3570XTL	SP3570-6050	3572WTL	SP3572-6250
3570-TR	SP3570-6050	3572XAR	SP3572-6250
3570-TL	SP3570-6050	3572XAL	SP3572-6250
3571WTR	SP3571-6050	3573WTR	SP3571-6050
3571WTL	SP3571-6050	3573WTL	SP3571-6050
3571-TR	SP3571-6050	3573-TR	SP3571-6050
3571-TL	SP3571-6050	3573-TL	SP3571-6050
3572XTR	SP3572-6250	3574WTR	SP3572-6250
3572XTL	SP3572-6250	3574WTL	SP3572-6250
3572-TR	SP3572-6250	3574ETR	SP3572-6250
3572-TL	SP3572-6250	3574ETL	SP3572-6250

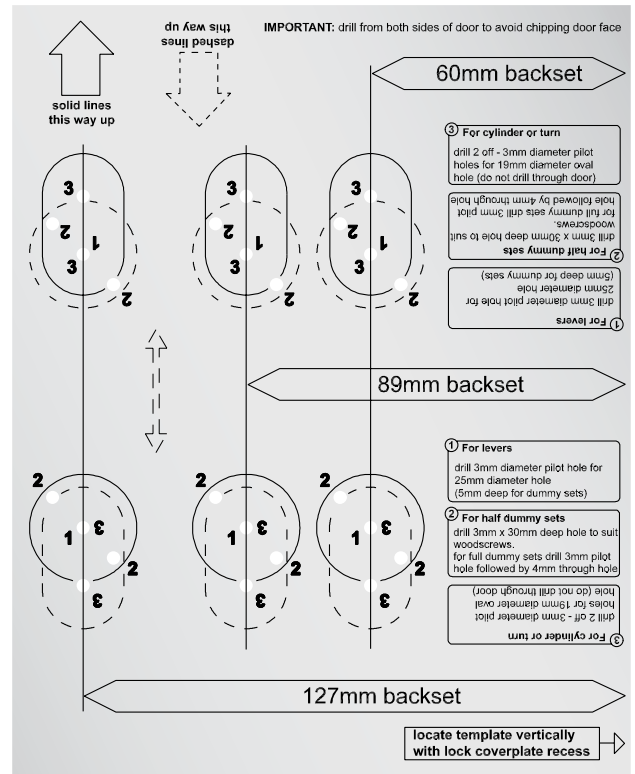

Installation Fixtures

Part Numbers	Description
RW98	Template for Lockwood 6780/6580 Series Mortice Locks (metal doors only)
RW99	Template for Lockwood 3770/ 3570 Series Mortice Locks

This stainless steel fixture makes installation easy. It is ideal when fitting furniture for large projects.

Note: Paper templates are supplied with all furniture.

Robert Watson Ordering Procedure

Ordering Procedure–Lever Sets

Sample part number RW70/01/A1LSA is made up of several sections. Choose your product by selecting an option from each section.

Robert Watson Collection

Product	Use	Function	Lever	Handing	Finish
RW	70	01	A1	L	SA

Product	Use	Function	Lever	Handing	Finish				
Robert Watson	RW	Operating Full Set	00	Tangent®	A1	Left Handed	L	Satin Anodised	SA
		Operating Half Set	01	Centre	A2	Right Handed	R	Powdercoat	PC
		Fixed Full Set	02	Centre D	A3	* Half sets only.			
		Fixed Half Set	03						
Use		<p>Note: Latch kits are ordered separately to lever sets. i.e. for RW30/00/A1LSA as RW531/60SC is also required.</p> <p>These include additional mounting hardware to suit lever sets and are not the same as a standard 530 latch.</p>							
If intended to fit using Lockwood 530 Latch		30							
If intended to fit using Lockwood 3770 and 3570 Series Mortice Locks		70							
If intended to fit using Lockwood 6780 and 6580 Narrow Style Mortice Lock (metal door only)		80							
If intended to fit to a metal door without lock		10							
If intended to fit to a timber door without lock		20							

Escutcheons - Accessories

Product	Use	Thickness	Finish
RW	06	50	SA

Product	Use	Function	Finish		
Robert Watson	RW	Doors 57mm – 62mm	62	Satin Anodised	SA
		Doors 51mm – 56mm	56	Powdercoat	PC
		Doors 45mm – 50mm	50		
		Doors 39mm – 44mm	44		
		Doors 35mm – 38mm	38		

Note: Refer to the decorative finishes section at the end of this catalogue for images of the full metal finishes and powder coat colour range available.

Robert Watson Ordering Procedure

Turnknobs and Emergency release turns - Accessories (For use with Lockwood Mortice Locks)

Product	Use	Finish
RW	07	SA

Product	Function	Finish
Robert Watson RW	Turnknob 07	Satin Anodised SA
	Privacy Indicating Turnknob 08	Powdercoat PC
	Turn Knob and Emergency Release Set 09	
	Turnknob/Privacy Indicating Emergency Release Set 10	
	Privacy Indicating Turnknob and Privacy Indicating Emergency Release Set 11	
	Privacy Indicating Emergency Release 14	

Turnknob and Emergency Release Turns - Accessories (For use with Lockwood 6260 Tubular Bolts)

Product	Function	Finish
RW	13	SA

Product	Function	Finish
Robert Watson RW	Turnknob and Emergency Release Set 13	Satin Anodised SA
		Powdercoat PC

Latch Kits - Accessories

Product	Latch	Backset	Finish
RW	531	60	SC

Product	Latch	Function	Finish
Robert Watson RW	Plain Latch 531	60mm backset 60	Satin Chrome SC
		70mm backset 70	
		127mm backset 127	

Latch Kits are supplied with adaptor to enable use with Robert Watson Furniture.

Note: Refer to the decorative finishes section at the end of this catalogue for images of the full metal finishes and powder coat colour range available.

1220 Symphony Series Brass Door Handles



Lockwood Symphony Series door furniture is manufactured from high quality solid brass. The comprehensive lever range matched with concealed screw fixings by way of threaded rose trims, provides a stylish look for the most elegant interiors.

The accessory range includes cylinder escutcheons, emergency turnknob and disabled accessible turnknobs. For installers, the unique turn mechanism adjusts to suit the thickness of the door and removes the need to cut tailbars to length.

A full range of finishes from satin chrome through to a range of brass finishes and polyester powder coat provides all the options for matching to interior designs.

Proudly Australian Made at our factory in Oakleigh to the highest quality standards for strength, durability and corrosion resistance.

Product Details

Dimensions	53mm diameter x 11.6mm.
Handing	A removable stop screw allows all symmetrically designed levers (e.g. Cadenza) to be handed on site. Levers of asymmetrical design (e.g. Veloce) cannot be reversed. Specify left or right handed when ordering.
Materials	All Lockwood roses and levers contained in the 1220 series are of solid brass construction.
Fixing	Fully concealed on both sides.
Door Thickness	Selector 3770 and Synergy 3570 Series: 32mm to 50mm Lockwood 5260 Latches: 33mm to 50mm
Decorative Finishes	<p>Standard Finish: Satin Chrome Brushed (SC)</p> <p>Non-Standard Finish: Chrome Plate (CP) Polished Brass (PB) Polyester Powdercoat (PC)</p> <p>Special Finish: Architectural Bronze (AZ) Architectural Bronze Unlacquered (AU) Antique Copper (AC) Polished Brass Unlacquered (BU) Satin Brass (SB) Oil Rubbed Bronze (ORB) Satin Brass Unlacquered (SBU)</p>
Privacy	Privacy function for Symphony Round Rose Furniture is achieved using the 3890 privacy adaptor and the Symphony 1321 interior rose. See ordering procedure for details.

Standards and Compliance



1220 Series has been successfully tested up to 4 hours with a fire rated Lockwood mortice lock on fire door assemblies (depending on type of doorset) in accordance with Australian Standard AS1905.1:2005, Fire Resistant Doorsets

D8

1220 Series lever sets have been successfully tested to conform with Level D8 (500,000 cycles) under Australian Standard AS4145.2-2008, Locksets and hardware for doors and windows



1220 Series lever sets in satin chrome finish has been successfully tested to AS 4145.2 2008 for Neutral Salt Spray – with SC Finish passing C10 1000 Hours - Extreme Corrosion Resistance. Suitable for coastal applications



1220 Series includes levers and turns (as shown) that meet the requirements of AS1428.1-2009, Design for access and mobility

Lockwood Brass Door Furniture is designed, assembled and customised in Australia to suit the requirements of the Australian Market.

1220 Symphony Series Brass Door Handles

BRASS CORE

The Symphony Series rose furniture features a 53mm solid brass rose with horizontal screw fixings, concealed on both sides by a threaded rose trim.

Supplied with:

2 x M4 x 65mm Stainless Steel Screws (SP1220-119)
1 x Instructions (1220-221)

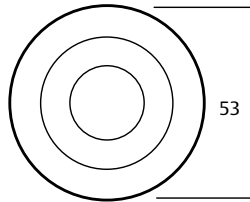

11.6

AS1428.1 Compliant Levers

Lever 102

Length	134.3mm
Projection	57.5mm
Finger clearance	40mm

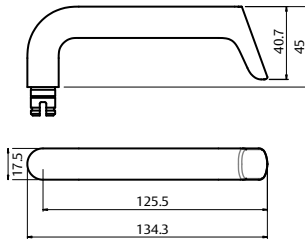

Lever 111

Length	130mm
Projection	48.5mm
Finger clearance	40mm

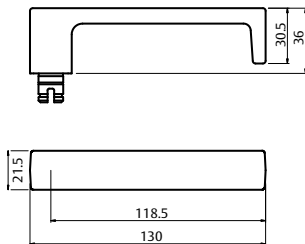

Lever 112

Length	130.5mm
Projection	48mm
Finger clearance	40mm

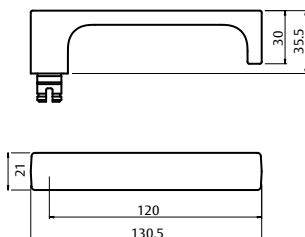

1220 Symphony Series Brass Door Handles

AS1428.1 Compliant Levers

Lever 115

Length	140.4mm
Projection	60mm
Finger clearance	40mm

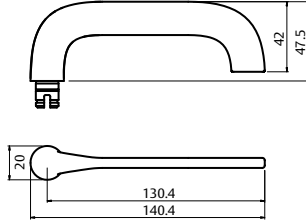

Lever 116

Length	140.5mm
Projection	58mm
Finger clearance	40mm

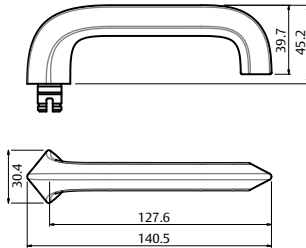

Lever 118

Length	128mm
Projection	58mm
Finger clearance	40mm

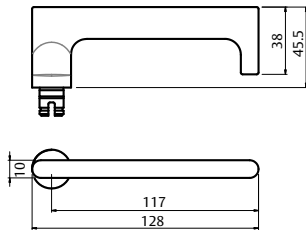

Lever 124

Length	130.5mm
Projection	59mm
Finger clearance	40mm

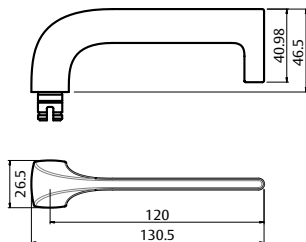

1220 Symphony Series Brass Door Handles

AS1428.1 Compliant Levers

Lever 131

Length	134.5mm
Projection	53mm
Finger clearance	40mm

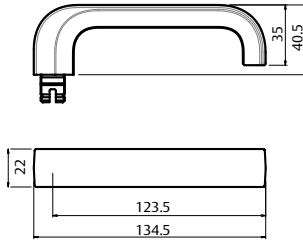

Lever 132

Length	130mm
Projection	57.5mm
Finger clearance	40mm

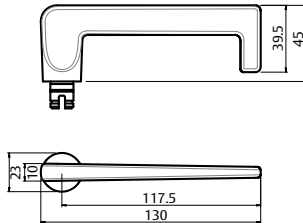

Lever 133

Length	130mm
Projection	53.5mm
Finger clearance	40mm

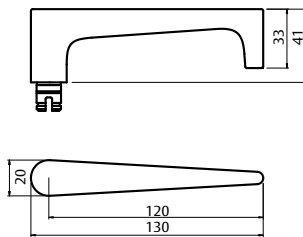

Lever 142

Length	130.5mm
Projection	55mm
Finger clearance	40mm

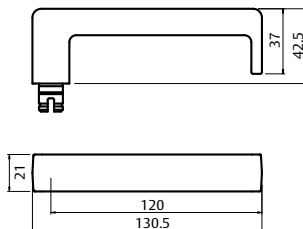

1220 Symphony Series Brass Door Handles

AS1428.1 Compliant Levers

Lever 144

Length	128.8mm
Projection	57.5mm
Finger clearance	40mm

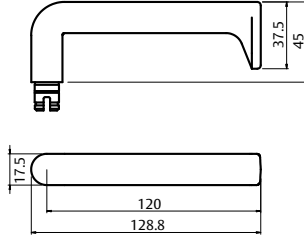

Lever 145

Length	130mm
Projection	58.5mm
Finger clearance	40mm

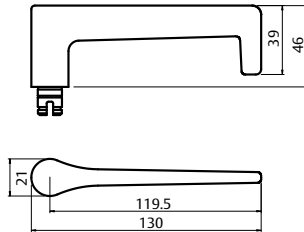

Lever 155

Length	129.3mm
Projection	57.5mm
Finger clearance	40mm

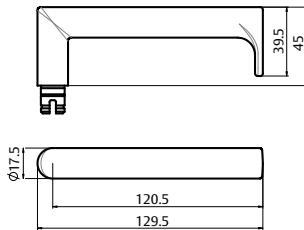

Lever 166

Length	130mm
Projection	48mm
Finger clearance	40mm

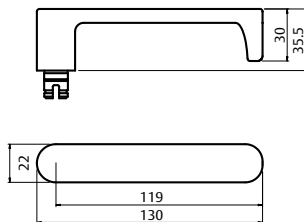

1220 Symphony Series Brass Door Handles

AS1428.1 Compliant Levers

Lever 180

Length	123.5mm
Projection	53.1mm
Finger clearance	40mm

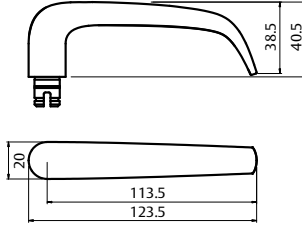

Lever 47

Length	120mm
Projection	49.6mm
Finger clearance	40mm

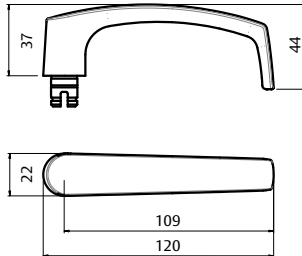

Lever 59

Length	121mm
Projection	47mm
Finger clearance	39.5mm

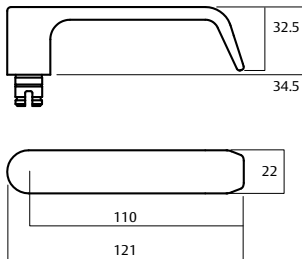

Lever 70

Length	121mm
Projection	53mm
Finger clearance	37mm

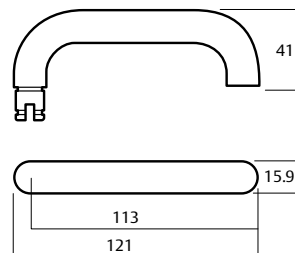

1220 Symphony Series Brass Door Handles

AS1428.1 Compliant Levers

Lever 74

Length	120mm
Projection	53mm
Finger clearance	45mm

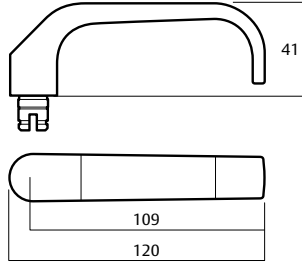

Lever 76

Length	125mm
Projection	48.5mm
Finger clearance	40mm

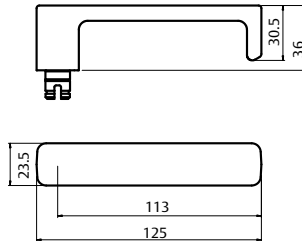

Lever 77

Length	121mm
Projection	51mm
Finger clearance	48.3mm

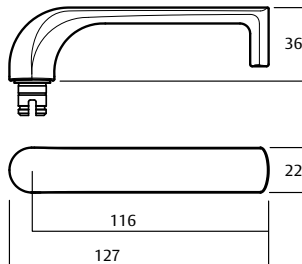

Lever 90

Length	118.5mm
Projection	51.6mm
Finger clearance	44mm

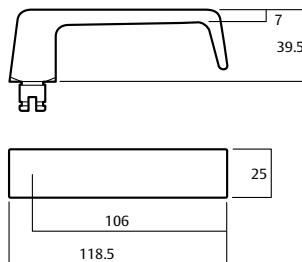

1220 Symphony Series Brass Door Handles

Non compliant lever/knob types

Lever 101

Length	130mm
Projection	48.5mm
Finger clearance	40mm

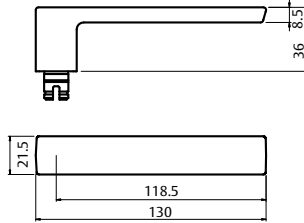

Lever 104

Length	133.8mm
Projection	57.5mm
Finger clearance	40mm

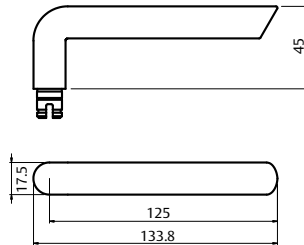

Lever 106

Length	130mm
Projection	48mm
Finger clearance	40mm

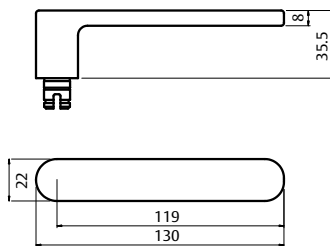

Lever 123

Length	130.5mm
Projection	59mm
Finger clearance	40mm

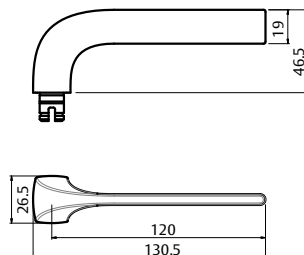

1220 Symphony Series Brass Door Handles

Non compliant lever/knob types

Lever 178

Length	130mm
Projection	63.6mm
Finger clearance	42mm

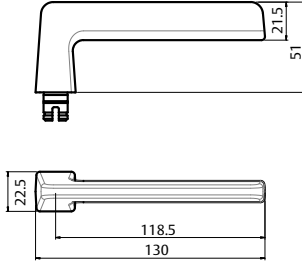

Lever 97

Length	120mm
Projection	50.5mm
Finger clearance	34.6mm

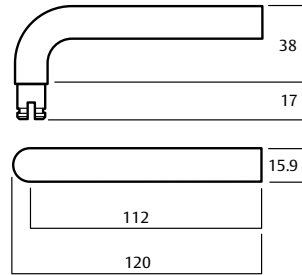

Knob 20

Diameter	50mm
Projection	73mm

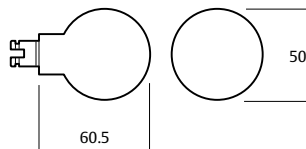

20 Knob can be used on outside rose only.

1220 Symphony Series Brass Door Handles

Handed Levers

Lever 41

Length	130mm
Projection	61.5mm
Finger clearance	40.5mm

* Lever is an asymmetrical design and therefore must be handed.

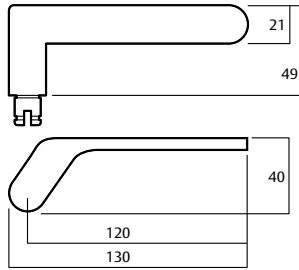

Lever 122

Length	130.5mm
Projection	59mm
Finger clearance	40mm

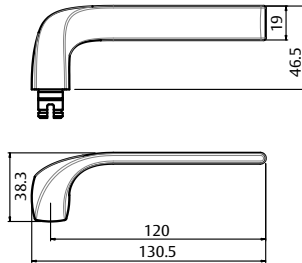

Lever 153

Length	120mm
Projection	70.6mm
Finger clearance	43mm

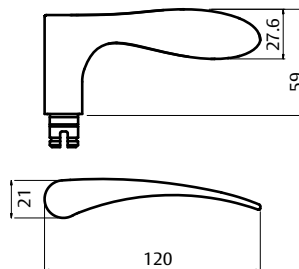

1220 Symphony Through Fix Escutcheon Kits

Through fix kits are optimised for use with Selector Series Mortise Locks. Supplied with two M4 64mm stainless screws for through fix installation.

Double Oval Cylinder Escutcheons Kit

Part Number 1226/6

Escutcheons supplied

Outside: Oval Cylinder Escutcheon

Inside: Oval Cylinder Escutcheon

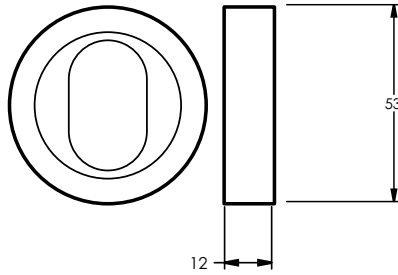

Outside

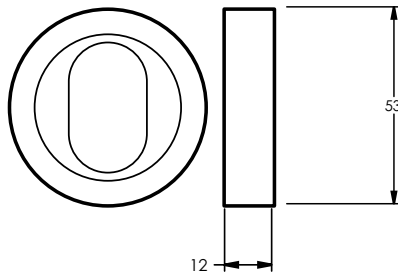

Inside

Oval Cylinder and Turnknob Escutcheons Kit

Part Number 1226/7N

Escutcheons supplied

Outside: Oval Cylinder Escutcheon

Inside: Turnknob Escutcheon

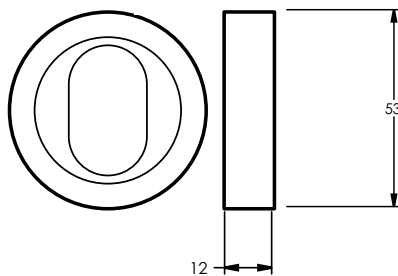

Outside

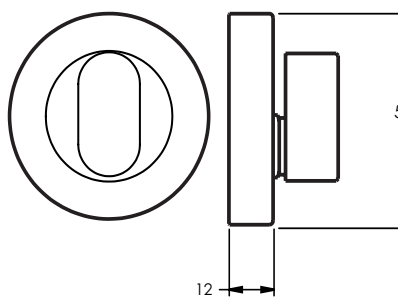

Inside

1220 Symphony Through Fix Escutcheon Kits

Privacy Indicating Emergency Turn and Disabled Accessible Turnknob Escutcheons Kit

Part Number 1228/9P

Escutcheons supplied

Outside: Privacy Indicating Emergency Turn Escutcheon

Inside: Privacy Indicating Disabled Accessible Turnknob Escutcheon

Door thickness: Suitable for 32 - 45mm doors.
Extended tail bars available for thicker doors.

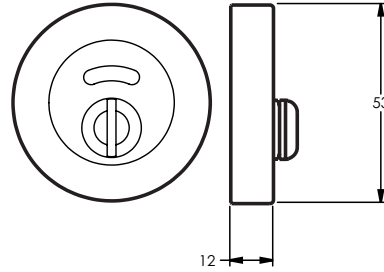

Outside

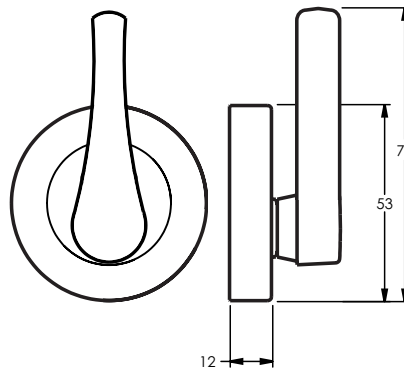

Inside

Note:
Common kit configurations are shown, for other kit variations please refer to the ordering procedure at the end of this section.

1220 Symphony Cylinder & Turn Escutcheons

Surface mounted escutcheons are optimised for use with Synergy Series Mortice Locks.

Oval Cylinder Escutcheon

Part Number 1226/I

Supplied with

2x Short & 2x Medium Wood Screws (SP1226-219)

(Replaces 1226)

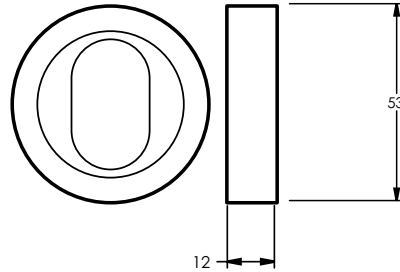

Turnknob Escutcheon

Part Number 1227/IN

Supplied with

2 x Short & 2 x Medium Wood Screws (SP1226-219)

1 x Short, Medium & Long Tail Bars and Spring (SP1227-219)

1 x Flat Tail Bar & Split Pin (SP12227-319)

1 x Instructions (1220-321)

(Replaces 1227)

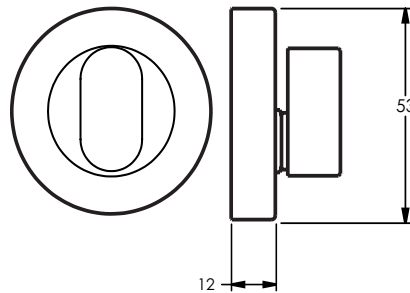

Privacy Indicating Turnknob Escutcheon

Part Number 1227/IP

Supplied with

2 x Short & 2 x Medium Wood Screws (SP1226-219)

1 x Short, Medium & Long Tail Bars and Spring (SP1227-219)

1 x Flat Tail Bar & Split Pin (SP12227-319)

1 x Instructions (1220-321)

(Replaces 1227P)

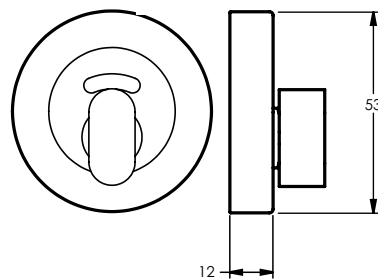

Emergency Turn Escutcheon

Part Number 1228/IN

Supplied with

2 x Short & 2 x Medium Wood Screws (SP1226-219)

1 x Emergency Tail Bar (SP1227-119)

(Replaces 1228)

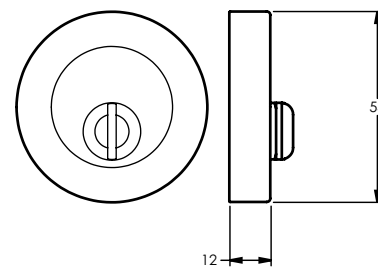

1220 Symphony Cylinder & Turn Escutcheons

Privacy Indicating Emergency Turn Escutcheon

Part Number 1228/IP

Supplied with

2 x Short & 2 x Medium Wood Screws (SP1226-219)
1 x Emergency Tail Bar (SP1227-119)

(Replaces 1228P)

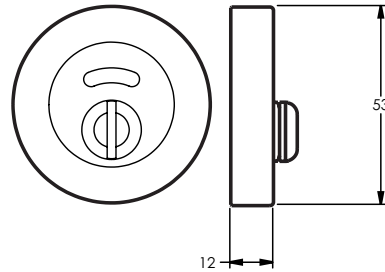

Disabled Accessible Turnknob

Part Number 1229/IN

Supplied with

2 x Short & 2 x Medium Wood Screws (SP1226-219)
1 x Short, Medium & Long Tail Bars and Spring (SP1227-219)
1 x Instructions (1220-321)

(Replaces 1227DT)

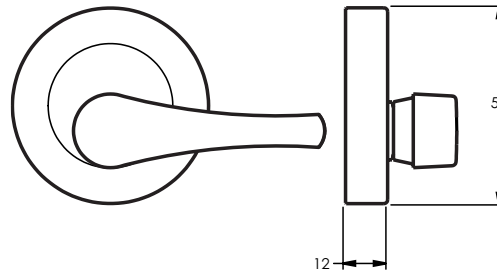

Disabled Accessible Privacy Indicating Turnknob

Part Number 1229/IP

Supplied with

2 x Short & 2 x Medium Wood Screws (SP1226-219)
1 x Short, Medium & Long Tail Bars and Spring (SP1227-219)
1 x Instructions (1220-321)

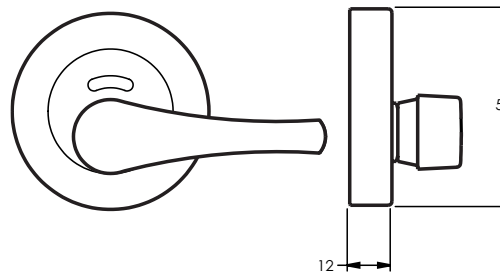

Door thickness: Suitable for 32 - 45mm doors.
Extended tail bars available for thicker doors.

1220 Symphony Privacy Adaptor

Privacy Adaptor

Part Number 3890

Dimensions 52mm x 11.6mm

Supplied with

2 x M4 x 77mm Stainless Steel Screws (SP0655MBK)
1 x Spindle 7.6mm x 90mm
1 x Instructions (3890-121)

Finishes

Satin Chrome (SC)
Chrome Plate (CP)
Powder Coat (PC)
Not available in
brass finishes

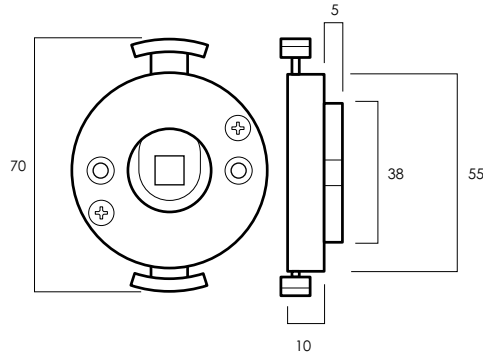

The 3890 Privacy Adaptor has a patented built in clutching mechanism which allows the engaged mode to be overridden by use of specified force applied in a single downward action on the lever. This will allow entry in an emergency situation without the use of any type of tool.

The privacy adaptor can be installed onto any existing Lockwood lever set and standard 5260 Tubular Latch.

1220 Symphony Series Ordering Procedure

Sample part number 1220/1221/41LCP is made up of several sections. Choose your product by selecting an option from each section.

Half Set

Note: Choose one rose only, exterior or interior.

Exterior Rose	Lever/ Knob	Handing	Finish
1220	41	L	CP

Full Set

Exterior Rose	Interior Rose	Lever/ Knob	Handing	Finish
1220	1221	41	L	CP

Exterior Rose Type	
Exterior Rose	1220
Exterior Blank Rose	1222
Exterior Fixed Rose	1224

Interior Rose Type	
Interior Rose	1221
Interior Blank Rose	1223
Interior Fixed Rose	1225
Interior Rose to suit 3890 Privacy Adaptor <small>*Only available in SC, CP and PC</small>	1321

AS1428.1 Compliant Lever Types

102	111	112
115	116	118
124	131	132
133	142	144
145	155	166
47	59	70
74	76	77
90		

Non compliant lever/knob types

101	104	123
178	97	20

Handed Levers

41	122	153
----	-----	-----

Handing	
Right Handed	R
Left Handed	L
NB: Omit if non-handed	

Finish	
Satin Chrome Brushed	SC
Chrome Plate	CP
Polished Brass	PB
Polyester Powdercoat	PC

Special Finishes

Polished Brass Unlacquered	BU
Satin Brass	SB
Satin Brass Unlacquered	SBU
Architectural Bronze	AZ
Architectural Bronze Unlacquered	AU
Antique Copper	AC
Oil Rubbed Bronze	ORB

Note: Refer to the decorative finishes section at the end of this catalogue for images of the full metal finishes and powder coat colour range available.

1220 Symphony Series Ordering Procedure

Escutcheon Kits

Through fix kits are optimised for use with Selector Series Mortice Locks. Supplied with two M4 64mm stainless screws for through fix installation.

Sample part number 1226/9NSC is made up of several sections.

The description of this part number is an oval cylinder and disabled accessible turnknob escutcheon kit.

Exterior Function	Interior Function	Privacy Indicator	Finish
1226	9	N	SC

Exterior Function	
Oval Cylinder	1226
Emergency Turn	1228

Notes:
Order 1226/I if only one oval cylinder escutcheon is required. Wood screws will be supplied for surface mounting.

1228/6 Kit is not applicable.

Interior Function	
Oval Cylinder	6
Oval Turnknob	7
Disabled Accessible Turnknob	9

Privacy Indicator	
Oval Cylinder	-
Non Indicating	N
Privacy Indicating	P

Note:
Privacy indicator applies for both exterior and interior functions.

Finish	
Satin Chrome Brushed	SC
Chrome Plate	CP
Polished Brass	PB
Polyester Powdercoat	PC

Special Finishes	
Polished Brass Unlacquered	BU
Satin Brass	SB
Satin Brass Unlacquered	SBU
Architectural Bronze	AZ
Architectural Bronze Unlacquered	AU
Antique Copper	AC
Oil Rubbed Bronze	ORB

Note: Refer to the decorative finishes section at the end of this catalogue for images of the full metal finishes and powder coat colour range available.

Refer to page 30 for reference guide.

1220 Symphony Series Ordering Procedure

Surface Mounted Escutcheons

Surface mounted escutcheons are optimised for use with Synergy Series Mortice Locks.

Supplied with wood screws to suit surface mounting on either side of the door.

Escutcheon Type	Fixing	Privacy Indicator	Finish
1229	I	P	SC

Escutcheon Type	
Oval Cylinder	1226
Oval Turnknob	1227
Emergency Turn	1228
Disabled Accessible Turnknob	1229

Fixing	
Wood Screw	
Surface Fixing	I

Privacy Indicator	
Oval Cylinder	-
Non Indicating	N
Privacy Indicating	P

Finish	
Satin Chrome Brushed	SC
Chrome Plate	CP
Polished Brass	PB
Polyester Powdercoat	PC

Special Finishes	
Polished Brass Unlacquered	BU
Satin Brass	SB
Satin Brass Unlacquered	SBU
Architectural Bronze	AZ
Architectural Bronze Unlacquered	AU
Antique Copper	AC
Oil Rubbed Bronze	ORB

Note: Refer to the decorative finishes section at the end of this catalogue for images of the full metal finishes and powder coat colour range available.











Refer to page 31 for reference guide.

1220 Symphony Series Reference Guide

Lockwood Brass Turns and Cylinder Escutcheons

Fitting: Through Fix Mounting

Optimized for Selector 3770 Series Mortice Locks









1220 Symphony Series Kits									
Image	Part Number	Handed	Kit Description		Mortice Lock/Bolt Compatibility				
			Exterior Function	Interior Function	Synergy 3570 Locks	Selector 3770 Locks	PT Mortice Locks	6260 Privacy Bolt	
	1226/6SC	No	Oval Cylinder Escutcheon	Oval Cylinder Escutcheon		✓	✓		
	1226/7NSC	No	Oval Cylinder Escutcheon	Oval Turnknob		✓	✓		
	1226/7PSC	No	Oval Cylinder Escutcheon	Privacy Indicating Oval Turnknob		✓	✓		
	1226/9NSC	No	Oval Cylinder Escutcheon	Disabled Accessible Turnknob		✓	✓		
	1226/9PSC	No	Oval Cylinder Escutcheon	Privacy Indicating Disabled Accessible Turnknob		✓	✓		
	1228/7NSC	No	Emergency Turn	Oval Turnknob		✓	✓	✓	
	1228/7PSC	No	Privacy Indicating Emergency Turn	Privacy Indicating Oval Turnknob		✓	✓	✓	
	1228P/7NSC	No	Privacy Indicating Emergency Turn	Oval Turnknob		✓	✓	✓	
	1228/9NSC	No	Emergency Turn	Disabled Accessible Turnknob		✓	✓	✓	
	1228/9PSC	No	Privacy Indicating Emergency Turn	Privacy Indicating Disabled Accessible Turnknob		✓	✓	✓	
	1228P/9NSC	No	Privacy Indicating Emergency Turn	Disabled Accessible Turnknob		✓	✓	✓	

1220 Symphony Series Reference Guide

Lockwood Brass Turns and Cylinder Escutcheons

Fitting: Surface Mounting

Optimized for Synergy 3570 Series Mortice Locks

1220 Symphony Series Surface Mounted Escutcheons				Mortice Lock/Bolt Compatibility				Replaced Codes	
Image	Part Number	Handed	Description	Synergy 3570 Locks	Selector 3770 Locks	PT Mortice Locks	6260 Privacy Bolt	Previous Surface Mounted Turns	Previous Pentagon External Turns
	1226/ISC	No	Oval Cylinder Escutcheon	✓	✓	✓		1226SC	1226/ESC
	1227/IPSC	No	Privacy Indicating Oval Turnknob Escutcheon	✓	✓	✓	✓	1227PSC	1227/EPSC
	1227/INSC	No	Non-Indicating Oval Turnknob Escutcheon	✓	✓	✓	✓	1227SC	1227/ENSC
	1228/INSC	No	Non-Indicating Emergency Turn Escutcheon	✓	✓	✓	✓	1228SC	1228/ENSC
	1228/IPSC	No	Privacy Indicating Emergency Turn Escutcheon	✓	✓	✓	✓	1228PSC	1228/EPSC
	1229/INSC	No	Non-Indicating Disabled Accessible Turnknob Escutcheon	✓		✓	✓	1227DT	1229/ENSC
	1229/IPSC	No	Privacy Indicating Disabled Accessible Turnknob Escutcheon	✓		✓	✓		1229/EPSC
	1226ESC	No	Euro Profile Cylinder Escutcheon	✓	✓	✓		-	-

1420 Symphony Series Square Rose Door Handles



Lockwood Symphony Series door furniture is manufactured from high quality solid brass material. The comprehensive lever range matched with concealed screw fixings by way of threaded rose trims, provides a stylish look for the most elegant interiors.

The accessory range includes cylinder escutcheons, emergency turnknobs and disabled accessible turnknobs. For installers, the unique turn mechanism adjusts to suit the thickness of the door and removes the need to cut tailbars to length.

A full range of finishes from satin chrome through to a range of brass finishes and polyester powder coat provides all the options for matching to interior designs.

Proudly Australian Made at our factory in Oakleigh to the highest quality standards for strength, durability and corrosion resistance.

Product Details

Dimensions	58mm x 58mm x 11.6mm.
Handing	A removable stop screw allows all symmetrically designed levers (e.g. Cadenza) to be handed on site. Levers of asymmetrical design (e.g. Veloce) cannot be reversed. Specify left or right handed when ordering.
Materials	All Lockwood roses and levers contained in the 1420 series are of solid brass construction.
Fixing	Fully concealed on both sides.
Door Thickness	Selector 3770 and Synergy 3570 Series: 32mm to 50mm Lockwood 5260 Latches: 33mm to 50mm

Standard Finish:
Satin Chrome Brushed (SC)

Non-Standard Finish:
Chrome Plate (CP)
Polished Brass (PB)
Polyester Powdercoat (PC)

Special Finish:
Architectural Bronze (AZ)
Architectural Bronze Unlacquered (AU)
Antique Copper (AC)
Polished Brass Unlacquered (BU)
Satin Brass (SB)
Oil Rubbed Bronze (ORB)
Satin Brass Unlacquered (SBU)

Decorative Finishes

Privacy
Privacy function for Symphony Square Rose Furniture is achieved using the 3690 privacy adaptor and standard Symphony 1421 interior rose.

Standards and Compliance



1420 Series has been successfully tested up to 4 hours with a fire rated Lockwood mortice lock on fire door assemblies (depending on type of doorset) in accordance with Australian Standard AS1905.1:2005, Fire Resistant Doorsets.

D8

1420 Series lever sets have been successfully tested to conform with Level D8 (500,000 cycles) under Australian Standard AS4145.2-2008, Locksets and hardware for doors and windows.



1420 Series lever sets in satin chrome finish has been successfully tested to AS 4145.2 2008 for Neutral Salt Spray – With SC Finish passing C10 1000 Hours - Extreme Corrosion Resistance. Suitable for coastal applications.



1420 Series includes levers and turns (as shown) that meet the requirements of AS1428.1-2009, Design for access and mobility.

Lockwood Brass Door Furniture is designed, assembled and customised in Australia to suit the requirements of the Australian Market.

1420 Symphony Series Square Rose Door Handles

BRASS CORE

The Symphony Series square rose furniture features a 58mm solid brass rose with horizontal screw fixings, concealed on both sides by a grub screw fixed, square rose trim.

Supplied with:

2 x M4 x 65mm Stainless Steel Screws (SP1220-119)
1 x Instructions (1220-221)

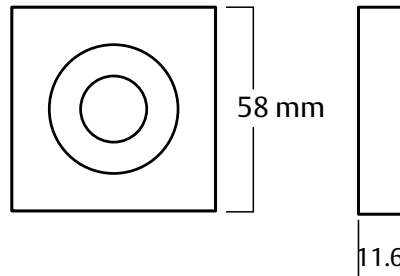

AS1428.1 Compliant Levers

Lever 102	
Length	134.3mm
Projection	57.5mm
Finger clearance	40mm

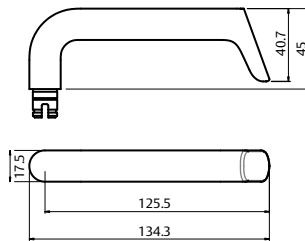

Lever 111	
Length	130mm
Projection	48.5mm
Finger clearance	40mm

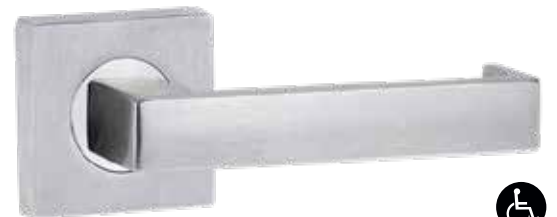
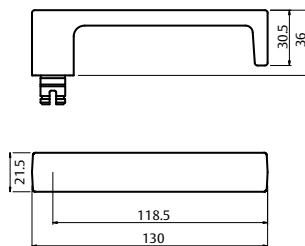

Lever 112	
Length	130.5mm
Projection	48mm
Finger clearance	40mm

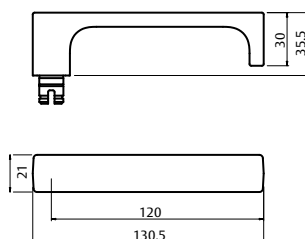

1420 Symphony Series Square Rose Door Handles

AS1428.1 Compliant Levers

Lever 115

Length	140.4mm
Projection	60mm
Finger clearance	40mm

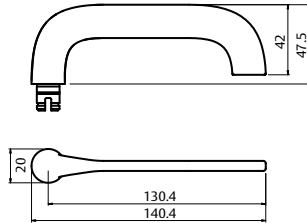

Lever 116

Length	140.5mm
Projection	58mm
Finger clearance	40mm

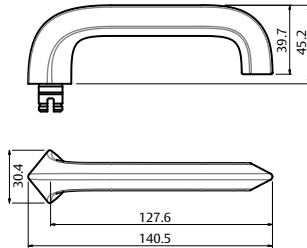

Lever 118

Length	128mm
Projection	58mm
Finger clearance	40mm

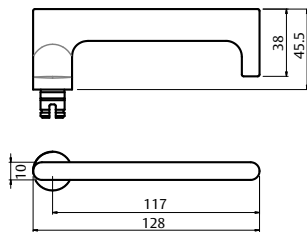

Lever 124

Length	130.5mm
Projection	59mm
Finger clearance	40mm

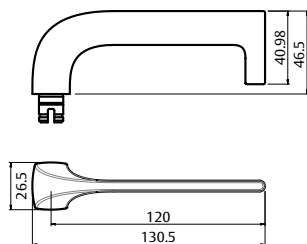

1420 Symphony Series Square Rose Door Handles

AS1428.1 Compliant Levers

Lever 131

Length	134.5mm
Projection	53mm
Finger clearance	40mm

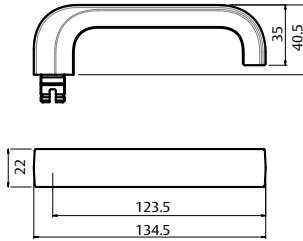

Lever 132

Length	130mm
Projection	57.5mm
Finger clearance	40mm

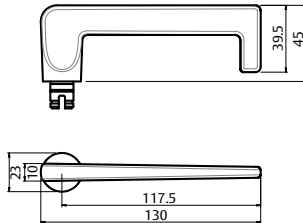

Lever 133

Length	130mm
Projection	53.5mm
Finger clearance	40mm

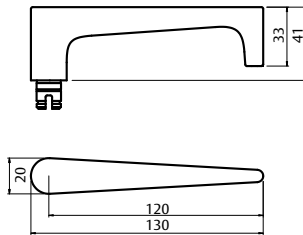

Lever 142

Length	130.5mm
Projection	55mm
Finger clearance	40mm

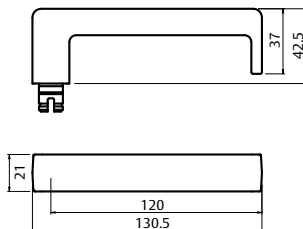

1420 Symphony Series Square Rose Door Handles

AS1428.1 Compliant Levers

Lever 144

Length	128.8mm
Projection	57.5mm
Finger clearance	40mm

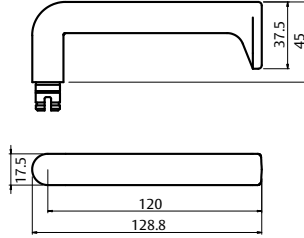

Lever 145

Length	130mm
Projection	58.5mm
Finger clearance	40mm

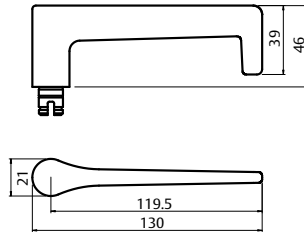

Lever 155

Length	129.3mm
Projection	57.5mm
Finger clearance	40mm

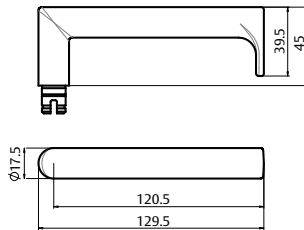

Lever 166

Length	130mm
Projection	48mm
Finger clearance	40mm

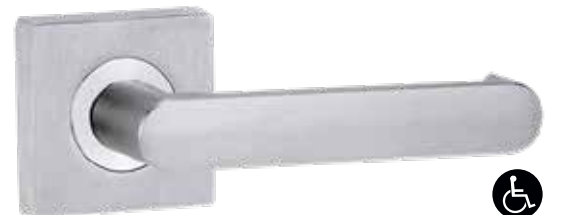
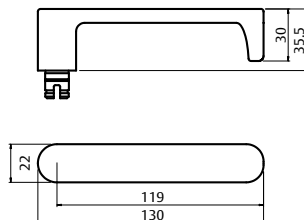

1420 Symphony Series Square Rose Door Handles

AS1428.1 Compliant Levers

Lever 180

Length	123.5mm
Projection	53.1mm
Finger clearance	40mm

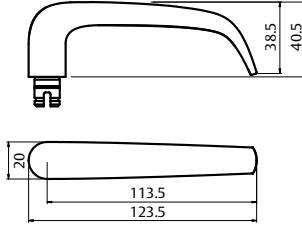

Lever 47

Length	120mm
Projection	49.6mm
Finger clearance	40mm

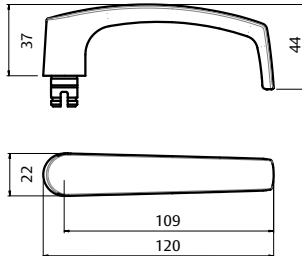

Lever 59

Length	121mm
Projection	47mm
Finger clearance	39.5mm

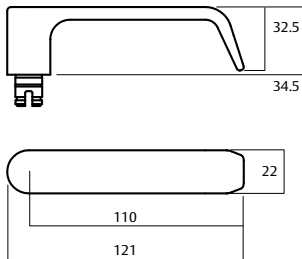

Lever 70

Length	121mm
Projection	53mm
Finger clearance	37mm

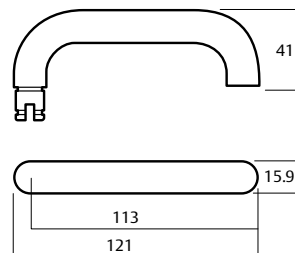

1420 Symphony Series Square Rose Door Handles

AS1428.1 Compliant Levers

Lever 74

Length	120mm
Projection	53mm
Finger clearance	45mm

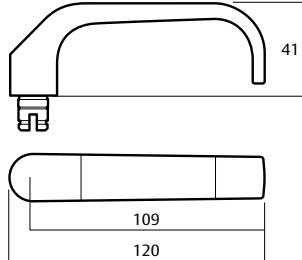

Lever 76

Length	125mm
Projection	48.5mm
Finger clearance	40mm

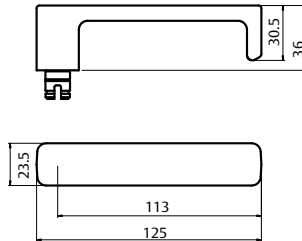

Lever 77

Length	121mm
Projection	51mm
Finger clearance	48.3mm

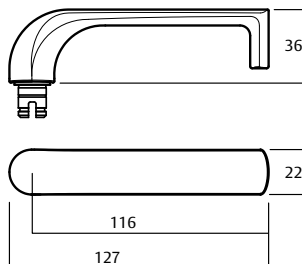

Lever 90

Length	118.5mm
Projection	51.6mm
Finger clearance	44mm

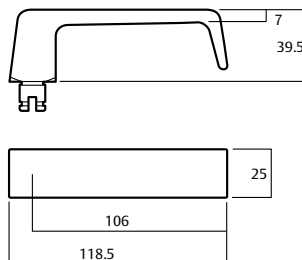

1420 Symphony Series Square Rose Door Handles

Non compliant lever/knob types

Lever 101

Length	130mm
Projection	48.5mm
Finger clearance	40mm

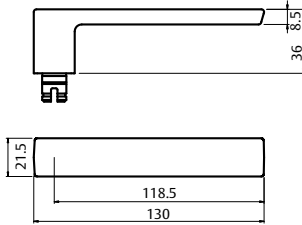

Lever 104

Length	133.8mm
Projection	57.5mm
Finger clearance	40mm

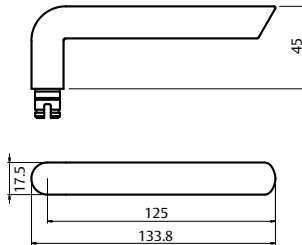

Lever 106

Length	130mm
Projection	48mm
Finger clearance	40mm

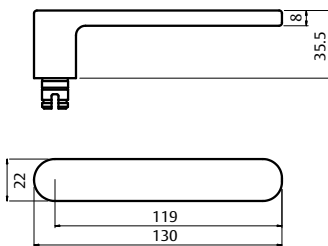

Lever 123

Length	130.5mm
Projection	59mm
Finger clearance	40mm

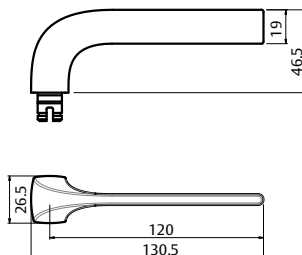

1420 Symphony Series Square Rose Door Handles

Non compliant lever/knob types

Lever 178

Length	130mm
Projection	63.6mm
Finger clearance	42mm

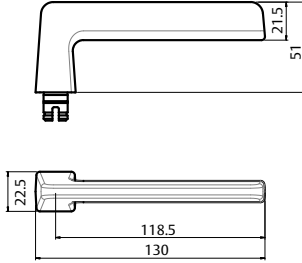

Lever 97

Length	120mm
Projection	50.5mm
Finger clearance	34.6mm

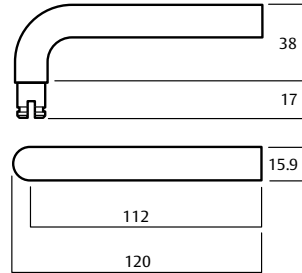

Knob 20

Diameter	50mm
Projection	73mm

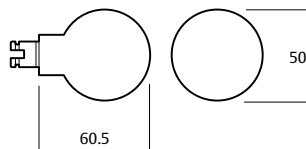

20 Knob can be used on outside rose only.

1420 Symphony Series Square Rose Door Handles

Handed Levers

Lever 41

Length	130mm
Projection	61.5mm
Finger clearance	40.5mm

* Lever is an asymmetrical design and therefore must be handed.

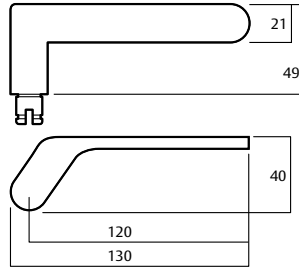

Lever 122

Length	130.5mm
Projection	59mm
Finger clearance	40mm

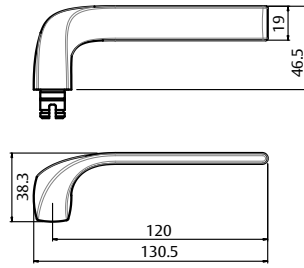

Lever 153

Length	120mm
Projection	70.6mm
Finger clearance	43mm

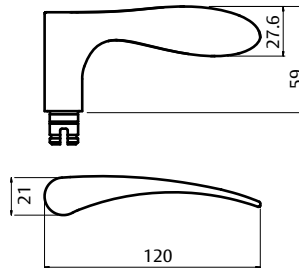

1420 Symphony Through Fix Escutcheon Kits

Through fix kits are optimised for use with Selector Series Mortice Locks. Supplied with two M4 64mm stainless screws for through fix installation.

Double Oval Cylinder Escutcheons Kit

Part Number 1426/6

Escutcheons supplied

Outside: Oval Cylinder Escutcheon

Inside: Oval Cylinder Escutcheon

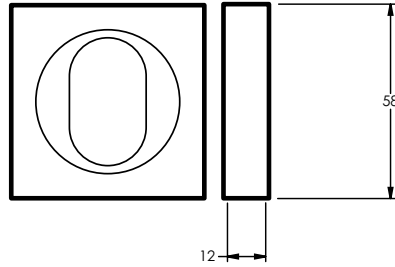

Outside

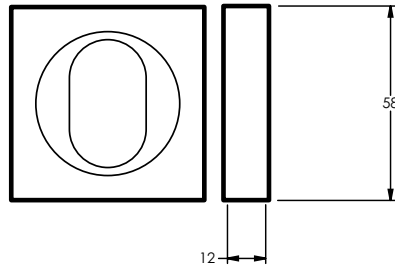

Inside

Oval Cylinder and Turnknob Escutcheons Kit

Part Number 1426/7N

Escutcheons supplied

Outside: Oval Cylinder Escutcheon

Inside: Turnknob Escutcheon

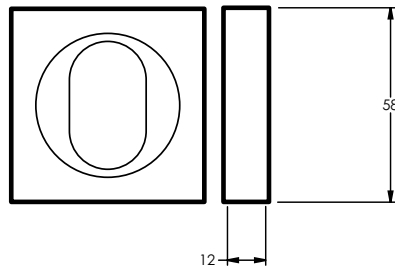

Outside

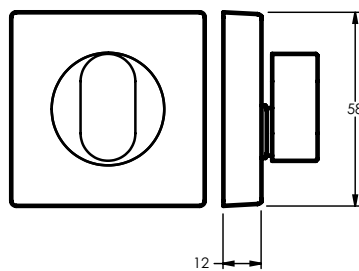

Inside

1420 Symphony Through Fix Escutcheon Kits

Privacy Indicating Emergency Turn and Disabled Accessible Turnknob Escutcheons Kit

Part Number 1428/9P

Escutcheons supplied

Outside: Privacy Indicating Emergency Turn Escutcheon

Inside: Privacy Indicating Disabled Accessible Turnknob Escutcheon

Door thickness: Suitable for 32 - 45mm doors.
Extended tail bars available for thicker doors.

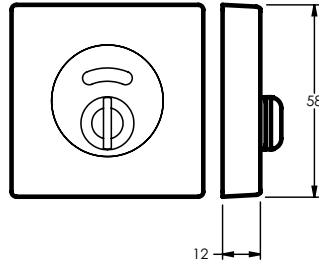

Outside

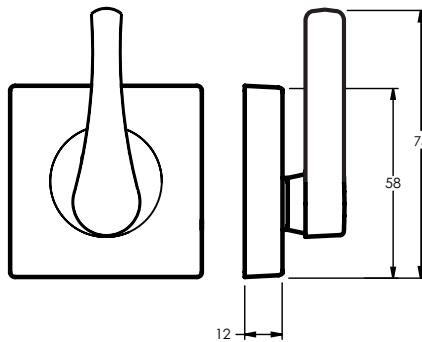

Inside

Note:
Common kit configurations are shown, for other kit variations please refer to the ordering procedure at the end of this section.

1420 Symphony Cylinder & Turn Escutcheons

Surface mounted escutcheons are optimised for use with Synergy Series Mortice Locks.

Oval Cylinder Escutcheon

Part Number 1426/I

Supplied with

2 x Short & 2 x Medium Wood Screws (SP1226-219)

(Replaces 1426)

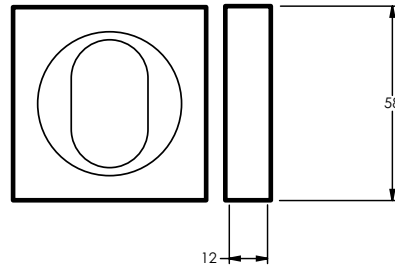

Turnknob Escutcheon

Part Number 1427/IN

Supplied with

2 x Short & 2 x Medium Wood Screws (SP1226-219)

1 x Short, Medium & Long Tail Bars and Spring (SP1227-219)

1 x Flat Tail Bar & Split Pin (SP12227-319)

1 x Instructions (1220-321)

(Replaces 1427)

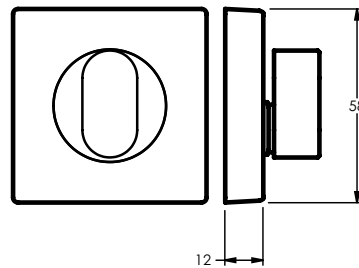

Privacy Indicating Turnknob Escutcheon

Part Number 1427/IP

Supplied with

2 x Short & 2 x Medium Wood Screws (SP1226-219)

1 x Short, Medium & Long Tail Bars and Spring (SP1227-219)

1 x Flat Tail Bar & Split Pin (SP12227-319)

1 x Instructions (1220-321)

(Replaces 1427P)

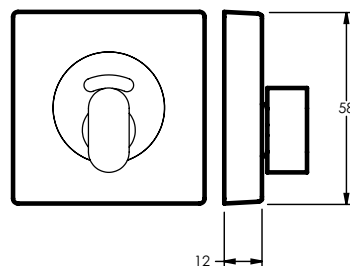

Emergency Turn Escutcheon

Part Number 1428/IN

Supplied with

2 x Short & 2 x Medium Wood Screws (SP1226-219)

1 x Emergency Tail Bar (SP1227-119)

(Replaces 1428P)

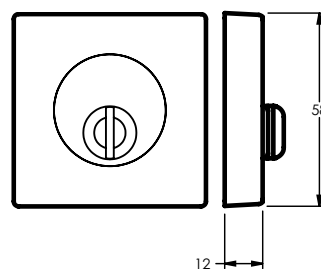

1420 Symphony Cylinder & Turn Escutcheons

Privacy Indicating Emergency Turn Escutcheon

Part Number 1428/IP

Supplied with

2 x Short & 2 x Medium Wood Screws (SP1226-219)
1 x Emergency Tail Bar (SP1227-119)

(Replaces 1428P)

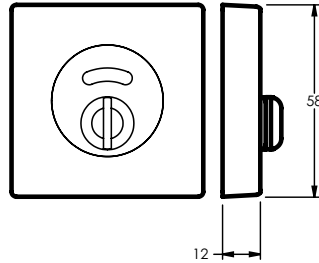

Disabled Accessible Turnknob

Part Number 1429/IN

Supplied with

2 x Short & 2 x Medium Wood Screws (SP1226-219)
1 x Short, Medium & Long Tail Bars and Spring (SP1227-219)
1 x Flat Tail Bar & Split Pin (SP1227-319)
1 x Instructions (1220-321)

(Replaces 1427DT)

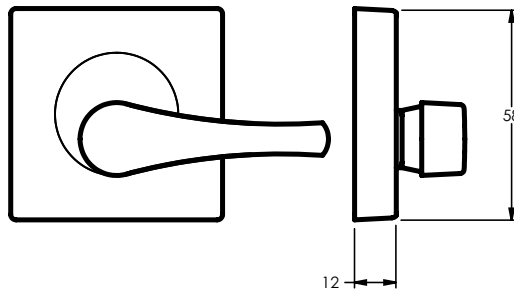

Disabled Accessible Privacy Indicating Turnknob

Part Number 1429/IP

Supplied with

2 x Short & 2 x Medium Wood Screws (SP1226-219)
1 x Short, Medium & Long Tail Bars and Spring (SP1227-219)
1 x Flat Tail Bar & Split Pin (SP1227-319)
1 x Instructions (1220-321)

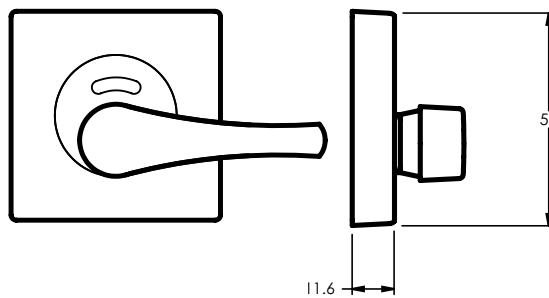

Door thickness: Suitable for 32 - 45mm doors.
Extended tail bars available for thicker doors.

1420 Symphony Privacy Adaptor

Privacy Adaptor 3690

Part Number 3690

Dimensions 58mm x 11.6mm

Supplied with

2 x M4 x 77mm Stainless Steel Screws (SP0655MBK)
1 x Spindle 7.6mm x 90mm
1 x Instructions (3890-121)

Finishes

Satin Chrome (SC)
Chrome Plate (CP)
Powder Coat (PC)
Not available in
brass finishes

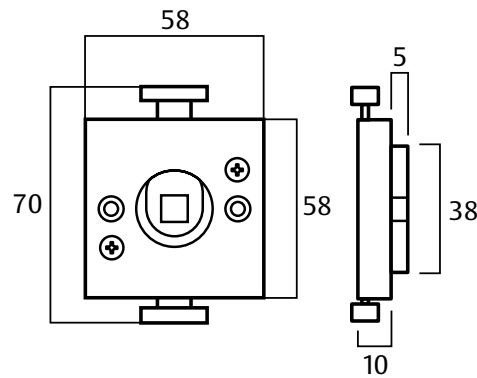

The 3690 Privacy Adaptor has a patented built in clutching mechanism which allows the engaged mode to be overridden by use of specified force applied in a single downward action on the lever. This will allow entry in an emergency situation without the use of any type of tool.

The privacy adaptor can be installed onto any existing Lockwood lever set and standard 5260 Tubular Latch.

1420 Symphony Series Ordering Procedure

Ordering Procedure

Sample part number 1420/1421/41LCP is made up of several sections. Choose your product by selecting an option from each section.

Half Set

Note: Choose one rose only, exterior or interior.

Exterior Rose	Lever/ Knob	Handing	Finish
1420	41	L	CP

Full Set

Exterior Rose	Interior Rose	Lever/ Knob	Handing	Finish
1420	1421	41	L	CP

Exterior Rose Type	
Exterior Rose	1420
Exterior Blank Rose	1422
Exterior Fixed Rose	1424

Interior Rose Type	
Interior Rose	1421
Interior Blank Rose	1423
Interior Fixed Rose	1425

AS1428.1 Compliant Lever Types		
102	111	112
115	116	118
124	131	132
133	142	144
145	155	166
47	59	70
74	76	77
90		

Non compliant lever/knob types		
101	104	123
178	97	20

Handed Levers		
41	122	153

Handing	
Right Handed	R
Left Handed	L
NB: Omit if non-handed	

Finish	
Satin Chrome Brushed	SC
Chrome Plate	CP
Polished Brass	PB
Polyester Powdercoat	PC

Special Finishes	
Polished Brass Unlacquered	BU
Satin Brass	SB
Satin Brass Unlacquered	SBU
Architectural Bronze	AZ
Architectural Bronze Unlacquered	AU
Antique Copper	AC
Oil Rubbed Bronze	ORB

Note: Refer to the decorative finishes section at the end of this catalogue for images of the full metal finishes and powder coat colour range available.

1420 Symphony Series Ordering Procedure

Escutcheon Kits

Through fix kits are optimised for use with Selector Series Mortice Locks. Supplied with two M4 64mm stainless screws for through fix installation.

Sample part number 1426/9NSC is made up of several sections. The description of this part number is an oval cylinder and disabled accessible turnknob escutcheon kit.

Exterior Function	Interior Function	Privacy Indicator	Finish
1426	9	N	SC

Exterior Function	
Oval Cylinder	1426
Emergency Turn	1428

Notes:

Order 1426/I if only one oval cylinder escutcheon is required. Wood screws will be supplied for surface mounting.

1428/6 Kit is not applicable.

Interior Function	
Oval Cylinder	6
Oval Turnknob	7
Disabled Accessible Turnknob	9

Privacy Indicator	
Oval Cylinder	-
Non Indicating	N
Privacy Indicating	P

Note:

Privacy indicator applies for both exterior and interior functions.

Finish	
Satin Chrome Brushed	SC
Chrome Plate	CP
Polished Brass	PB
Polyester Powdercoat	PC

Special Finishes	
Polished Brass Unlacquered	BU
Satin Brass	SB
Satin Brass Unlacquered	SBU
Architectural Bronze	AZ
Architectural Bronze Unlacquered	AU
Antique Copper	AC
Oil Rubbed Bronze	ORB

Note: Refer to the decorative finishes section at the end of this catalogue for images of the full metal finishes and powder coat colour range available.

Refer to page 50 for reference guide.

1420 Symphony Series Ordering Procedure

Surface Mounted Escutcheons

Surface mounted escutcheons are optimised for use with Synergy Series Mortice Locks.

Supplied with wood screws to suit surface mounting on either side of the door.

Escutcheon Type	Fixing	Privacy Indicator	Finish
1429	I	P	SC

Escutcheon Type	Fixing	Privacy Indicator	Finish
Oval Cylinder 1426	Wood Screw	Oval Cylinder -	Satin Chrome Brushed SC
Oval Turnknob 1427	Surface Fixing I	Non Indicating N	Chrome Plate CP
Emergency Turn 1428		Privacy Indicating P	Polished Brass PB
Disabled Accessible Turnknob 1429			Polyester Powdercoat PC

Special Finishes	
Polished Brass Unlacquered	BU
Satin Brass	SB
Satin Brass Unlacquered	SBU
Architectural Bronze	AZ
Architectural Bronze Unlacquered	AU
Antique Copper	AC
Oil Rubbed Bronze	ORB

Note: Refer to the decorative finishes section at the end of this catalogue for images of the full metal finishes and powder coat colour range available.











Refer to page 51 for reference guide.

1420 Symphony Series Reference Guide

Lockwood Brass Turns and Cylinder Escutcheons

Fitting: Through Fix Mounting

Optimized for Selector 3770 Series Mortice Locks









1420 Symphony Series Kits									
Image	Part Number	Handed	Kit Description		Mortice Lock/Bolt Compatibility				
			Exterior Function	Interior Function	Synergy 3570 Locks	Selector 3770 Locks	PT Mortice Locks	6260 Privacy Bolt	
	1426/6SC	No	Oval Cylinder Escutcheon	Oval Cylinder Escutcheon		✓	✓		
	1426/7NSC	No	Oval Cylinder Escutcheon	Oval Turnknob		✓	✓		
	1426/7PSC	No	Oval Cylinder Escutcheon	Privacy Indicating Oval Turnknob		✓	✓		
	1426/9NSC	No	Oval Cylinder Escutcheon	Disabled Accessible Turnknob		✓	✓		
	1426/9PSC	No	Oval Cylinder Escutcheon	Privacy Indicating Disabled Accessible Turnknob		✓	✓		
	1428/7NSC	No	Emergency Turn	Oval Turnknob		✓	✓	✓	
	1428/7PSC	No	Privacy Indicating Emergency Turn	Privacy Indicating Oval Turnknob		✓	✓	✓	
	1428P/7NSC	No	Privacy Indicating Emergency Turn	Oval Turnknob		✓	✓	✓	
	1428/9NSC	No	Emergency Turn	Disabled Accessible Turnknob		✓	✓	✓	
	1428/9PSC	No	Privacy Indicating Emergency Turn	Privacy Indicating Disabled Accessible Turnknob		✓	✓	✓	
	1428P/9NSC	No	Privacy Indicating Emergency Turn	Disabled Accessible Turnknob		✓	✓	✓	

1420 Symphony Series Reference Guide

Lockwood Brass Turns and Cylinder Escutcheons

Fitting: Surface Mounting

Optimized for Synergy 3570 Series Mortice Locks

1420 Symphony Series Surface Mounted Escutcheons				Mortice Lock/Bolt Compatibility				Replaced Codes	
Image	Part Number	Handed	Description	Synergy 3570 Locks	Selector 3770 Locks	PT Mortice Locks	6260 Privacy Bolt	Previous Surface Mounted Turns	Previous Pentagon External Turns
	1426/ISC	No	Oval Cylinder Escutcheon	✓	✓	✓		1426SC	1426/ESC
	1427/IPSC	No	Privacy Indicating Oval Turnknob Escutcheon	✓	✓	✓	✓	1427PSC	1427/EPSC
	1427/INSC	No	Non-Indicating Oval Turnknob Escutcheon	✓	✓	✓	✓	1427SC	1427/ENSC
	1428/INSC	No	Non-Indicating Emergency Turn Escutcheon	✓	✓	✓	✓	1428SC	1428/ENSC
	1428/IPSC	No	Privacy Indicating Emergency Turn Escutcheon	✓	✓	✓	✓	1428PSC	1428/EPSC
	1429/INSC	No	Non-Indicating Disabled Accessible Turnknob Escutcheon	✓		✓	✓	1427DT	1429/ENSC
	1429/IPSC	No	Privacy Indicating Disabled Accessible Turnknob Escutcheon	✓		✓	✓		1429/EPSC
	1426ESC	No	Euro Profile Cylinder Escutcheon	✓	✓	✓		-	-

1360 Series Brass Door Handles



Lockwood 1360 Series door furniture is manufactured from high quality solid brass material. The comprehensive lever range matched with ease of installation and compatibility with a wide range of Mortice Locks defines simple and reliable.

The accessory range includes cylinder escutcheons, emergency turns and disabled accessible turnknobs. For installers, the unique turn mechanism adjusts to suit the thickness of the door and removes the need to cut tailbars to length.

A full range of finishes from satin chrome through to a range of brass finishes and polyester powder coat provides all the options for matching to interior designs.

Proudly Australian Made at our factory at Oakleigh to the highest quality standards for strength, durability and corrosion resistance.

Product Details

Dimensions	65.5mm diameter x 11.6mm.
Handing	A removable stop screw allows all symmetrically designed levers (e.g. Cadenza) to be handed on site. Levers of asymmetrical design (e.g. Veloce) cannot be reversed. Specify left or right handed when ordering.
Materials	All Lockwood roses and levers contained in the 1360 series are of solid brass construction.
Fixing	Roses are designed to fit back to back. If outside rose is specified with concealed fixing, then the inside rose must be visible fixed. Roses numbered 1360, 1362, and 1364 are concealed fixed, roses numbered 1361, 1363 and 1365 are visible fixed.
Door Thickness	Selector 3770 and Synergy 3770 Series: 32mm to 50mm Lockwood 5260 Latches: 33mm to 50mm
Decorative Finishes	<p>Standard Finish: Satin Chrome Brushed (SC)</p> <p>Non-Standard Finish: Chrome Plate (CP) Polished Brass (PB) Polyester Powdercoat (PC)</p> <p>Special Finish: Architectural Bronze (AZ) Architectural Bronze Unlacquered (AU) Antique Copper (AC) Polished Brass Unlacquered (BU) Satin Brass (SB) Oil Rubbed Bronze (ORB) Satin Brass Unlacquered (SBU)</p>

Standards and Compliance



1360 Series has been successfully tested up to 4 hours with a fire rated Lockwood mortice lock on fire door assemblies (depending on type of doorset) in accordance with Australian Standard AS1905.1:2005, Fire Resistant Doorsets.

D8

1360 Series lever sets have been successfully tested to conform with Level D8 (500,000 cycles) under Australian Standard AS4145.2-2008, Locksets and hardware for doors and windows.



1360 Series lever sets in satin chrome finish has been successfully tested to AS 4145.2 2008 for Neutral Salt Spray – With SC Finish passing C10 1000 Hours - Extreme Corrosion Resistance. Suitable for coastal applications.



1360 Series includes levers and turns (as shown) that meet the requirements of AS1428.1-2009, Design for access and mobility.

Lockwood Brass Door Furniture is designed, assembled and customised in Australia to suit the requirements of the Australian Market.

1360 Series Brass Door Handles

BRASS CORE

The 1360 Series rose furniture features a 65mm solid brass rose with diagonal screw fixings, concealed on the outside and visible on the inside.

Supplied with:

- 2 x M4 x 65mm Stainless Steel Screws (SP1220-119)
- 1 x Instructions (1220-221)

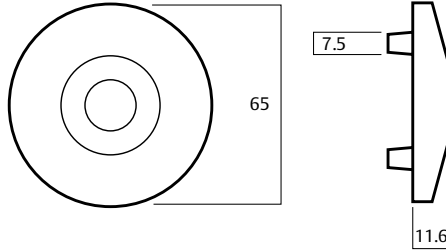

AS1428.1 Compliant Levers

Lever 102	
Length	134.3mm
Projection	57.5mm
Finger clearance	40mm

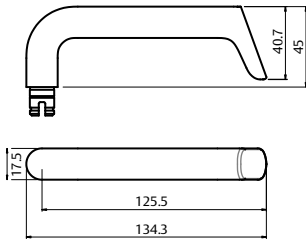

Lever 111	
Length	130mm
Projection	48.5mm
Finger clearance	40mm

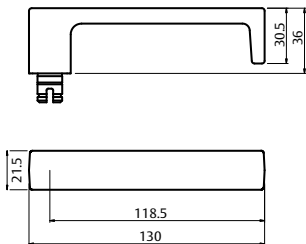

Lever 112	
Length	130.5mm
Projection	48mm
Finger clearance	40mm

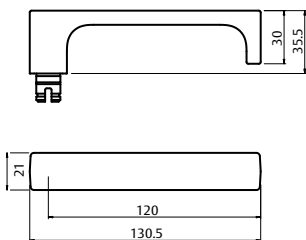

1360 Series Brass Door Handles

AS1428.1 Compliant Levers

Lever 115

Length	140.4mm
Projection	60mm
Finger clearance	40mm

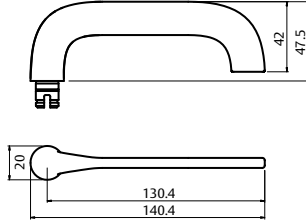

Lever 116

Length	140.5mm
Projection	58mm
Finger clearance	40mm

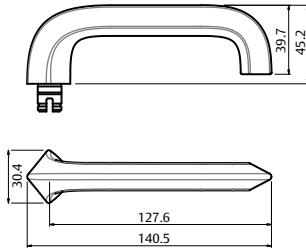

Lever 118

Length	128mm
Projection	58mm
Finger clearance	40mm

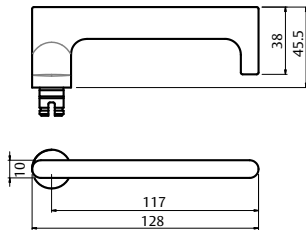

Lever 124

Length	130.5mm
Projection	59mm
Finger clearance	40mm

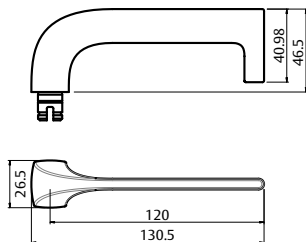

1360 Series Brass Door Handles

AS1428.1 Compliant Levers

Lever 131

Length	134.5mm
Projection	53mm
Finger clearance	40mm

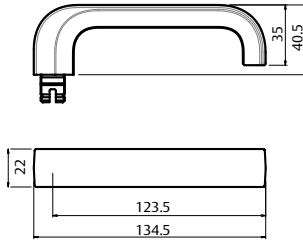

Lever 132

Length	130mm
Projection	57.5mm
Finger clearance	40mm

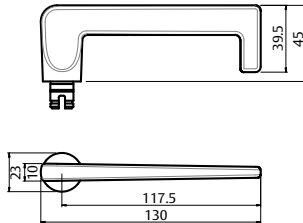

Lever 133

Length	130mm
Projection	53.5mm
Finger clearance	40mm

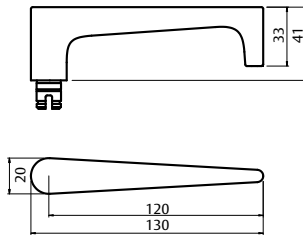

Lever 142

Length	130.5mm
Projection	55mm
Finger clearance	40mm

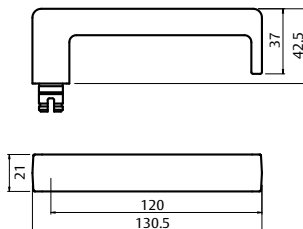

1360 Series Brass Door Handles

AS1428.1 Compliant Levers

Lever 144

Length	128.8mm
Projection	57.5mm
Finger clearance	40mm

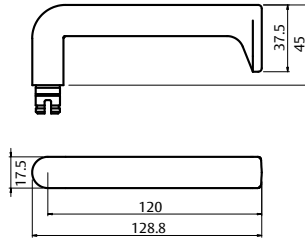

Lever 145

Length	130mm
Projection	58.5mm
Finger clearance	40mm

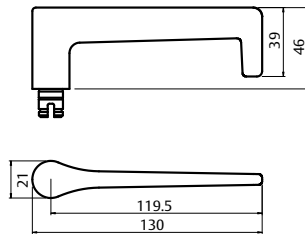

Lever 155

Length	129.3mm
Projection	57.5mm
Finger clearance	40mm

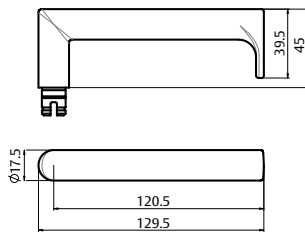

Lever 166

Length	130mm
Projection	48mm
Finger clearance	40mm

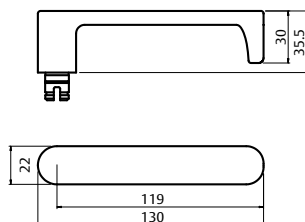

1360 Series Brass Door Handles

AS1428.1 Compliant Levers

Lever 180	
Length	123.5mm
Projection	53.1mm
Finger clearance	40mm

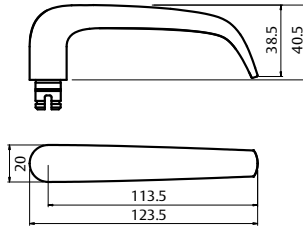

Lever 47	
Length	120mm
Projection	49.6mm
Finger clearance	40mm

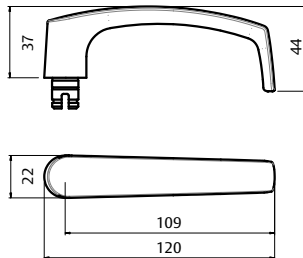

Lever 59	
Length	121mm
Projection	47mm
Finger clearance	39.5mm

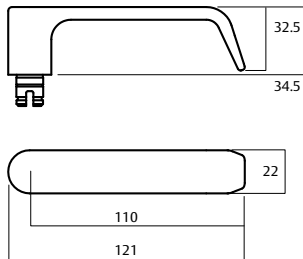

Lever 70	
Length	121mm
Projection	53mm
Finger clearance	37mm

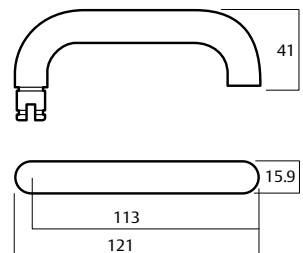

1360 Series Brass Door Handles

AS1428.1 Compliant Levers

Lever 74

Length	120mm
Projection	53mm
Finger clearance	45mm

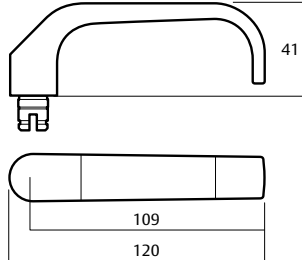

Lever 76

Length	125mm
Projection	48.5mm
Finger clearance	40mm

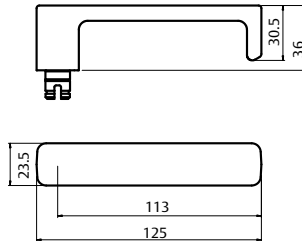

Lever 77

Length	121mm
Projection	51mm
Finger clearance	48.3mm

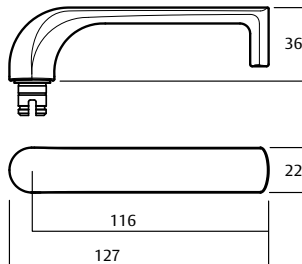

Lever 90

Length	118.5mm
Projection	51.6mm
Finger clearance	44mm

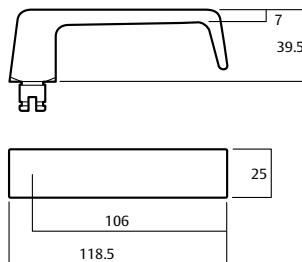

1360 Series Brass Door Handles

Non compliant lever/knob types

Lever 101

Length	130mm
Projection	48.5mm
Finger clearance	40mm

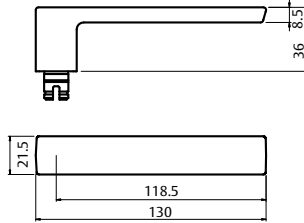

Lever 104

Length	133.8mm
Projection	57.5mm
Finger clearance	40mm

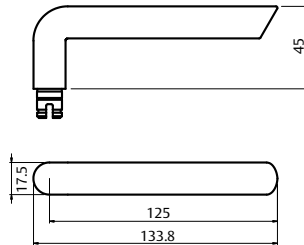

Lever 106

Length	130mm
Projection	48mm
Finger clearance	40mm

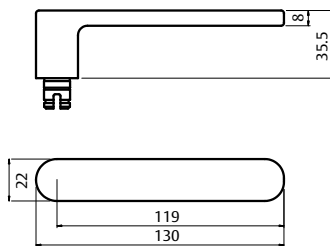

Lever 123

Length	130.5mm
Projection	59mm
Finger clearance	40mm

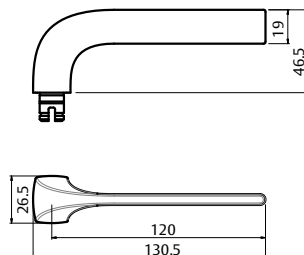

1360 Series Brass Door Handles

Non compliant lever/knob types

Lever 178

Length	130mm
Projection	63.6mm
Finger clearance	42mm

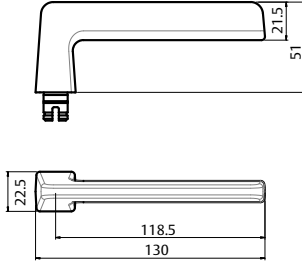

Lever 97

Length	120mm
Projection	50.5mm
Finger clearance	34.6mm

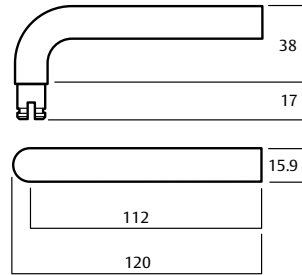

Knob 20

Diameter	50mm
Projection	73mm

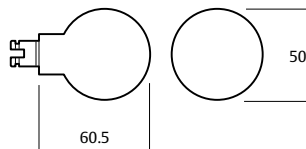

20 Knob can be used on outside rose only.

1360 Series Brass Door Handles

Handed Levers

Lever 41

Length	130mm
Projection	61.5mm
Finger clearance	40.5mm

* Lever is an asymmetrical design and therefore must be handed.

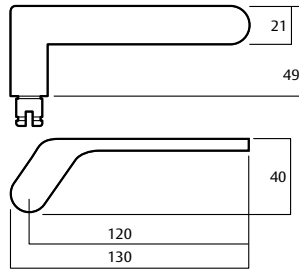

Lever 122

Length	130.5mm
Projection	59mm
Finger clearance	40mm

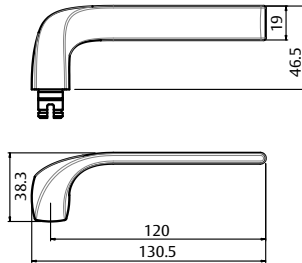

Lever 153

Length	120mm
Projection	70.6mm
Finger clearance	43mm

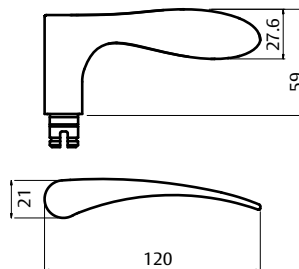

1360 Series Through Fix Escutcheon Kits

Through fix kits are optimised for use with Selector Series Mortice Locks. Supplied with two M4 64mm stainless screws for through fix installation.

Double Oval Cylinder Escutcheons Kit

Part Number 1366/6

Escutcheons supplied

Outside: Oval Cylinder Escutcheon

Inside: Oval Cylinder Escutcheon

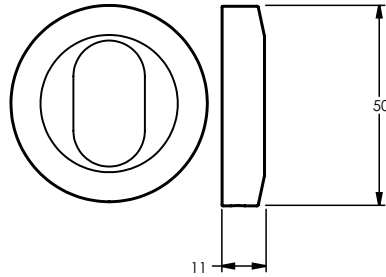

Outside

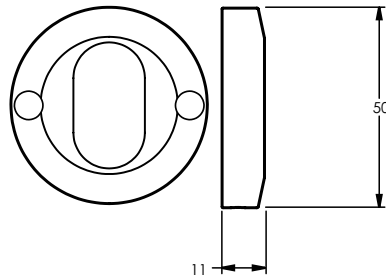

Inside

Oval Cylinder and Turnknob Escutcheons Kit

Part Number 1366/7N

Escutcheons supplied

Outside: Oval Cylinder Escutcheon

Inside: Turnknob Escutcheon

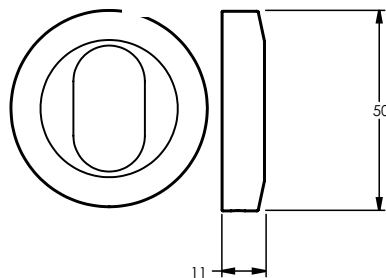

Outside

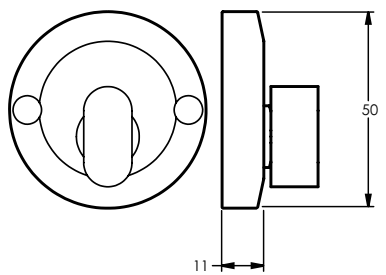

Inside

1360 Series Through Fix Escutcheon Kits

Privacy Indicating Emergency Turn and Disabled Accessible Turnknob Escutcheons Kit

Part Number 1368/9P

Escutcheons supplied

Outside: Privacy Indicating Emergency Turn Escutcheon

Inside: Privacy Indicating Disabled Accessible Turnknob Escutcheon

Door thickness: Suitable for 32 - 45mm doors.
Extended tail bars available for thicker doors.

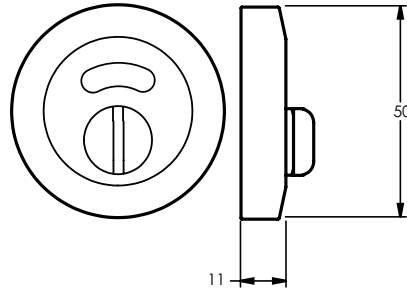

Outside

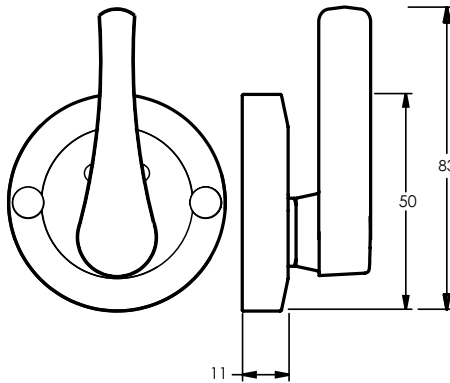

Inside

Note:
Common kit configurations are shown, for other kit variations please refer to the ordering procedure at the end of this section.

1360 Series Cylinder & Turn Escutcheons

Surface mounted escutcheons are optimised for use with Synergy Series Mortice Locks.

Oval Cylinder Escutcheon

Part Number 1366/E

Supplied with

- 2 x M4 x 65mm Stainless Steel Screws (SP1220-119)
- 1 x Allen Key (SP1366-14)
- 1 x Grub Screw M4 x 8mm (SPV0272 PBK)

(Replaces 1366)

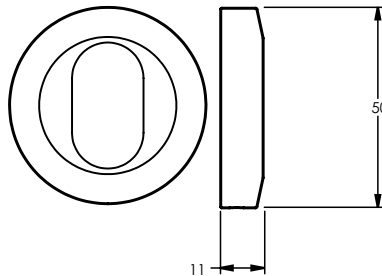

Turnknob Escutcheon

Part Number 1367/IN

Supplied with

- 2 x Short & 2 x Medium Wood Screws (SP1226-219)
- 1 x Short, Medium & Long Tail Bars and Spring (SP1227-219)
- 1 x Flat Tail Bar & Split Pin (SP1227-319)
- 1 x Instructions (1220-321)

(Replaces 1367)

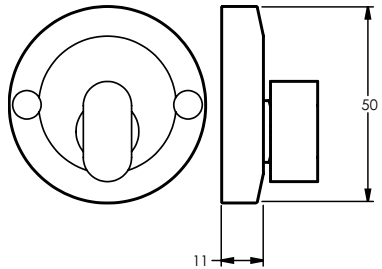

Privacy Indicating Turnknob Escutcheon

Part Number 1367/IP

Supplied with

- 2 x Short & 2 x Medium Wood Screws (SP1226-219)
- 1 x Short, Medium & Long Tail Bars and Spring (SP1227-219)
- 1 x Flat Tail Bar & Split Pin (SP1227-319)
- 1 x Instructions (1220-321)

(Replaces 1367P)

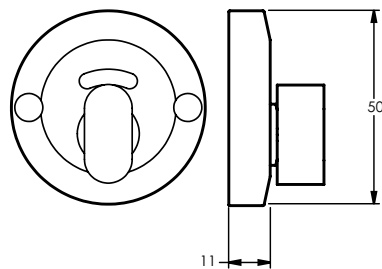

Emergency Turn Escutcheon

Part Number 1368/IN

Supplied with

- 2 x Short & 2 x Medium Wood Screws (SP1226-219)
- 1 x Emergency Tail Bar (SP1227-119)

(Replaces 1368)

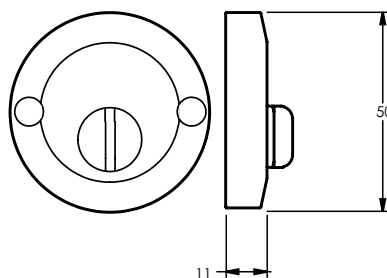

1360 Series Cylinder & Turn Escutcheons

Privacy Indicating Emergency Turn Escutcheon

Part Number 1368/IP

Supplied with

2 x Short & 2 x Medium Wood Screws (SP1226-219)
1 x Emergency Tail Bar (SP1227-119)

(Replaces 1368P)

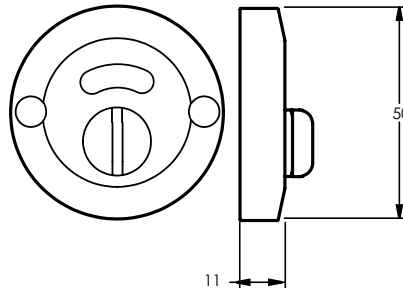

Disabled Accessible Turnknob

Part Number 1369/IN

Supplied with

2 x Short & 2 x Medium Wood Screws (SP1226-219)
1 x Short, Medium & Long Tail Bars and Spring (SP1227-219)
1 x Instructions (1220-321)

(Replaces 1367DT)

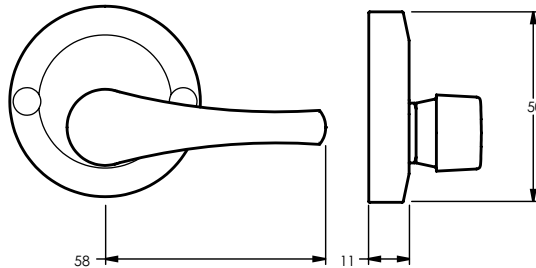

Disabled Accessible Privacy Indicating Turnknob

Part Number 1369/IP

Supplied with

2 x Short & 2 x Medium Wood Screws (SP1226-219)
1 x Short, Medium & Long Tail Bars and Spring (SP1227-219)
1 x Instructions (1220-321)

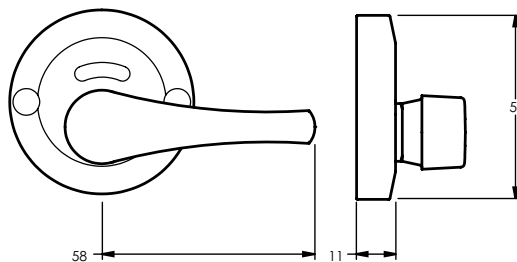

Door thickness: Suitable for 32 - 45mm doors.
Extended tail bars available for thicker doors.

1360 Series Ordering Procedure

Ordering Procedure

Sample part number 1360/41LCP is made up of several sections. Choose your product by selecting an option from each section.

Half Set

Note: Choose one rose only, exterior or interior.

Exterior Rose	Lever/ Knob	Handing	Finish
1360	41	L	CP

Full Set

Exterior Rose	Interior Rose	Lever/ Knob	Handing	Finish
1360	1361	41	L	CP

Exterior Rose Type	
Exterior Rose	1360
Exterior Blank Rose	1362
Exterior Fixed Rose	1364

Interior Rose Type	
Interior Rose	1361
Interior Blank Rose	1363
Interior Fixed Rose	1365

AS1428.1 Compliant Lever Types		
102	111	112
115	116	118
124	131	132
133	142	144
145	155	166
47	59	70
74	76	77
90		

Non compliant lever/knob types		
101	104	123
178	97	20

Handed Levers		
41	122	153

Handing	
Right Handed	R
Left Handed	L
NB: Omit if non-handed	

Finish	
Satin Chrome Brushed	SC
Chrome Plate	CP
Polished Brass	PB
Polyester Powdercoat	PC

Non - Standard Finishes	
Polished Brass Unlacquered	BU
Satin Brass	SB
Satin Brass Unlacquered	SBU
Architectural Bronze	AZ
Architectural Bronze Unlacquered	AU
Antique Copper	AC
Oil Rubbed Bronze	ORB

Note: Refer to the decorative finishes section at the end of this catalogue for images of the full metal finishes and powder coat colour range available.

1360 Series Ordering Procedure

Escutcheon Kits

Through fix kits are optimised for use with Selector Series Mortice Locks. Supplied with two M4 64mm stainless screws for through fix installation.

Sample part number 1366/9NSC is made up of several sections. The description of this part number is an oval cylinder and disabled accessible turnknob escutcheon kit.

Exterior Function	Interior Function	Privacy Indicator	Finish
1366	9	N	SC

Exterior Function	
Oval Cylinder	1366
Emergency Turn	1368

Notes:

Order 1366/E if only one oval cylinder escutcheon is required. A grub screw will be supplied to allow for concealed fixing.

1368/6 Kit is not applicable.

Interior Function	
Oval Cylinder	6
Oval Turnknob	7
Disabled Accessible Turnknob	9

Privacy Indicator	
Oval Cylinder	-
Non Indicating	N
Privacy Indicating	P

Note: Privacy indicator applies for both exterior and interior functions.

Finish	
Satin Chrome Brushed	SC
Chrome Plate	CP
Polished Brass	PB
Polyester Powdercoat	PC

Non - Standard Finishes

Polished Brass Unlacquered	BU
Satin Brass	SB
Satin Brass Unlacquered	SBU
Architectural Bronze	AZ
Architectural Bronze Unlacquered	AU
Antique Copper	AC
Oil Rubbed Bronze	ORB

Note: Refer to the decorative finishes section at the end of this catalogue for images of the full metal finishes and powder coat colour range available.

Refer to page 69 for reference guide.

1360 Series Ordering Procedure

Surface Mounted Escutcheons

Surface mounted escutcheons are optimised for use with Synergy Series Mortice Locks.

Supplied with wood screws to suit surface mounting on either side of the door.

Escutcheon Type	Fixing	Privacy Indicator	Finish
1369	I	P	SC

Escutcheon Type	Fixing	Privacy Indicator	Finish
Oval Cylinder	Wood Screw Surface Fixing I	Oval Cylinder -	Satin Chrome Brushed SC
Oval Turn	Grub Screw	Non Indicating N	Chrome Plate CP
Emergency Turn	Concealed Fixing E*	Privacy Indicating P	Polished Brass PB
Disabled Accessible Turn			Polyester Powdercoat PC

Special Finishes	
Polished Brass Unlacquered	BU
Satin Brass	SB
Satin Brass Unlacquered	SBU
Architectural Bronze	AZ
Architectural Bronze Unlacquered	AU
Antique Copper	AC
Oil Rubbed Bronze	ORB

Note:
*Only applicable when ordering with 1366 Oval Cylinder Escutcheon. The 1366/E will be supplied with a grub screw to allow for concealed fixing.

Note: Refer to the decorative finishes section at the end of this catalogue for images of the full metal finishes and powder coat colour range available.











Refer to page 70 for reference guide.

1360 Series Reference Guide

Lockwood Brass Turns and Cylinder Escutcheons

Fitting: Through Fix Mounting

Optimized for Selector 3770 Series Mortice Locks

1360 Series Kits									
Image	Part Number	Handed	Kit Description			Mortice Lock/Bolt Compatibility			
			Exterior Function	Interior Function	Synergy 3570 Locks	Selector 3770 Locks	PT Mortice Locks	6260 Privacy Bolt	
	1366/6SC	No	Oval Cylinder Escutcheon	Oval Cylinder Escutcheon		✓	✓		
	1366/7NSC	No	Oval Cylinder Escutcheon	Oval Turnknob		✓	✓		
	1366/7PSC	No	Oval Cylinder Escutcheon	Privacy Indicating Oval Turnknob		✓	✓		
	1366/9NSC	No	Oval Cylinder Escutcheon	Disabled Accessible Turnknob		✓	✓		
	1366/9PSC	No	Oval Cylinder Escutcheon	Privacy Indicating Disabled Accessible Turnknob		✓	✓		
	1368/7NSC	No	Emergency Turn	Oval Turnknob		✓	✓	✓	
	1368/7PSC	No	Privacy Indicating Emergency Turn	Privacy Indicating Oval Turnknob		✓	✓	✓	
	1368P/7NSC	No	Privacy Indicating Emergency Turn	Oval Turnknob		✓	✓	✓	
	1368/9NSC	No	Emergency Turn	Disabled Accessible Turnknob		✓	✓	✓	
	1368/9PSC	No	Privacy Indicating Emergency Turn	Privacy Indicating Disabled Accessible Turnknob		✓	✓	✓	
	1368P/9NSC	No	Privacy Indicating Emergency Turn	Disabled Accessible Turnknob		✓	✓	✓	









1360 Series Reference Guide

Lockwood Brass Turns and Cylinder Escutcheons

Fitting: Surface Mounting

Optimized for Synergy 3570 Series Mortice Locks

1360 Series Surface Mounted Escutcheons

Image	Part Number	Handed	Description	Mortice Lock/Bolt Compatibility				Replaced Codes	
				Synergy 3570 Locks	Selector 3770 Locks	PT Mortice Locks	6260 Privacy Bolt	Previous Surface Mounted Turns	Previous Pentagon External Turns
	1366/ESC	No	Oval Cylinder Escutcheon	✓	✓	✓		1366SC	1366/ESC
	1367/IPSC	No	Privacy Indicating Oval Turnknob Escutcheon	✓	✓	✓	✓	1367PSC	1367/EPSC
	1367/INSC	No	Non-Indicating Oval Turnknob Escutcheon	✓	✓	✓	✓	1367SC	1367/ENSC
	1368/INSC	No	Non-Indicating Emergency Turn Escutcheon	✓	✓	✓	✓	1368SC	1368/ENSC
	1368/IPSC	No	Privacy Indicating Emergency Turn Escutcheon	✓	✓	✓	✓	1368PSC	1368/EPSC
	1369/INSC	No	Non-Indicating Disabled Accessible Turnknob Escutcheon	✓	✓	✓	✓	1367DT	1369/ENSC
	1369/IPSC	No	Privacy Indicating Disabled Accessible Turnknob Escutcheon	✓	✓	✓	✓		1369/EPSC
	1366ESC	No	Euro Profile Cylinder Escutcheon	✓	✓	✓		-	-

1370 Series Brass Door Handles



Lockwood 1370 Series door furniture is manufactured from high quality solid brass material. The comprehensive lever range matched with ease of installation and compatibility with a wide range of Mortice Locks defines simple and reliable.

The accessory range includes cylinder escutcheons, emergency turns and disabled accessible turnknobs. For installers, the unique turn mechanism adjusts to suit the thickness of the door and removes the need to cut tailbars to length.

A full range of finishes from satin chrome through to a range of brass finishes and polyester powder coat provides all the options for matching to interior designs.

Proudly Australian Made at our factory at Oakleigh to the highest quality standards for strength, durability and corrosion resistance.

Product Details

Dimensions	62.5mm diameter x 11.6mm.
Materials	All Lockwood roses and levers contained in the 1370 series are of solid brass construction.
Fixing	Roses are designed to fit back to back. If outside rose is specified with concealed fixing, then the inside rose must be visible fixed. Roses numbered 1370, 1372 and 1374 are concealed fixed, roses numbered 1371, 1373 and 1375 are visible fixed.
Door Thickness	Selector 3770 and Synergy 3570 Series: 32mm to 50mm Lockwood 5260 Latches: 33mm to 50mm
Decorative Finishes	<p>Standard Finish: Satin Chrome Brushed (SC)</p> <p>Non-Standard Finish: Chrome Plate (CP) Polished Brass (PB) Polyester Powdercoat (PC)</p> <p>Special Finish: Architectural Bronze (AZ) Architectural Bronze Unlacquered (AU) Antique Copper (AC) Polished Brass Unlacquered (BU) Satin Brass (SB) Oil Rubbed Bronze (ORB) Satin Brass Unlacquered (SBU)</p>

Standards and Compliance



1370 Series has been successfully tested up to 4 hours with a fire rated Lockwood mortice lock on fire door assemblies (depending on type of doorset) in accordance with Australian Standard AS1905.1:2005, Fire Resistant Doorsets.

1370 Series lever sets have been successfully tested to conform with Level D8 (500,000 cycles) under Australian Standard AS4145.2-2008, Locksets and hardware for doors and windows.

D8



1370 Series lever sets in satin chrome finish has been successfully tested to AS 4145.2 2008 for Neutral Salt Spray – With SC Finish passing C10 1000 Hours - Extreme Corrosion Resistance. Suitable for coastal applications.



1370 Series includes levers and turns (as shown) that meet the requirements of AS1428.1-2009, Design for access and mobility.

Lockwood Brass Door Furniture is designed, assembled and customised in Australia to suit the requirements of the Australian Market.

1370 Series Brass Door Handles

BRASS CORE

The 1370 Series rose furniture features a 62mm solid brass rose with diagonal screw fixings, concealed on the outside and visible on the inside.

Supplied with:

2 x M4 x 65mm Stainless Steel Screws (SP1220-119)
1 x Instructions (1220-221)

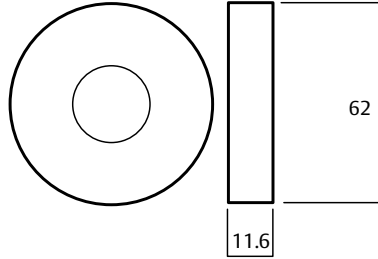

AS1428.1 Compliant Levers

Lever 102

Length	134.3mm
Projection	57.5mm
Finger clearance	40mm

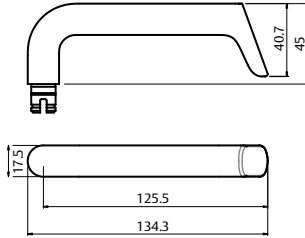

Lever 111

Length	130mm
Projection	58mm
Finger clearance	40mm

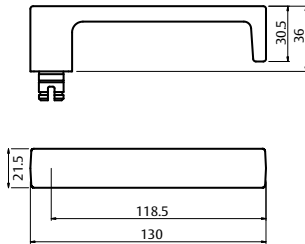

Lever 112

Length	130.5mm
Projection	48mm
Finger clearance	40mm

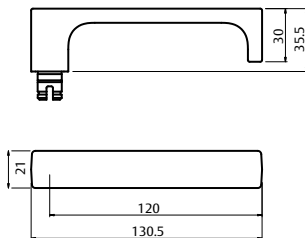

1370 Series Brass Door Handles

AS1428.1 Compliant Levers

Lever 115

Length	140.4mm
Projection	60mm
Finger clearance	40mm

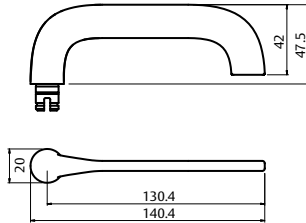

Lever 116

Length	140.5mm
Projection	47.6mm
Finger clearance	40mm

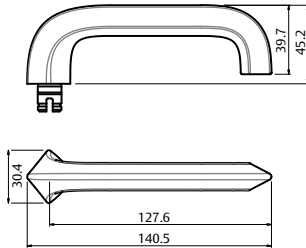

Lever 118

Length	128mm
Projection	58mm
Finger clearance	40mm

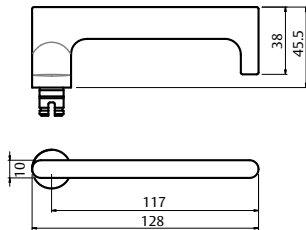

Lever 124

Length	130.5mm
Projection	59mm
Finger clearance	40mm

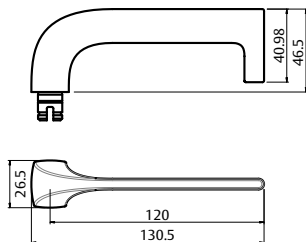

1370 Series Brass Door Handles

AS1428.1 Compliant Levers

Lever 131	
Length	134.5mm
Projection	53mm
Finger clearance	40mm

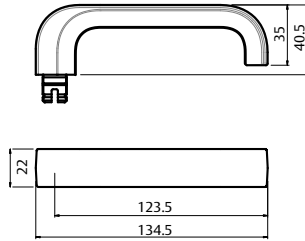

Lever 132	
Length	130mm
Projection	57.5mm
Finger clearance	40mm

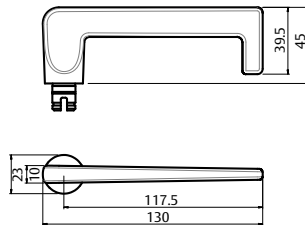

Lever 133	
Length	130mm
Projection	53.5mm
Finger clearance	40mm

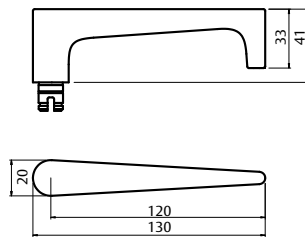

Lever 142	
Length	130.5mm
Projection	55mm
Finger clearance	40mm

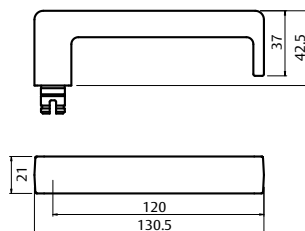

1370 Series Brass Door Handles

AS1428.1 Compliant Levers

Lever 144

Length	128.8mm
Projection	57.5mm
Finger clearance	40mm

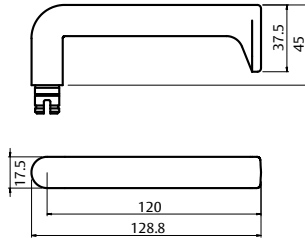

Lever 145

Length	130mm
Projection	58.5mm
Finger clearance	40mm

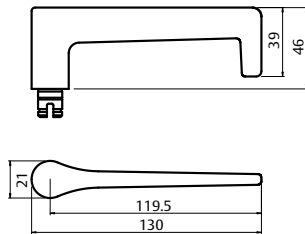

Lever 155

Length	129.3mm
Projection	57.5mm
Finger clearance	40mm

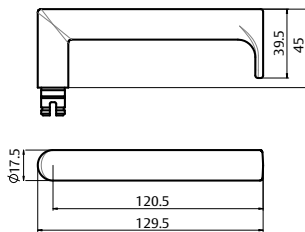

Lever 166

Length	130mm
Projection	48mm
Finger clearance	40mm

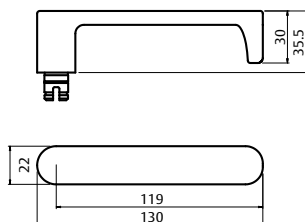

1370 Series Brass Door Handles

AS1428.1 Compliant Levers

Lever 180

Length	123.5mm
Projection	53.1mm
Finger clearance	40mm

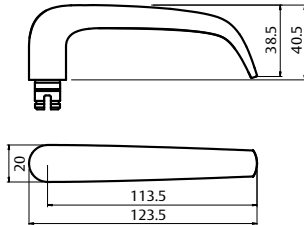

Lever 47

Length	120mm
Projection	49.6mm
Finger clearance	40mm

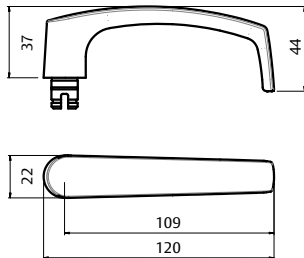

Lever 59

Length	121mm
Projection	47mm
Finger clearance	39.5mm

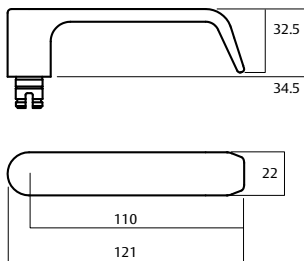

Lever 70

Length	121mm
Projection	53mm
Finger clearance	37mm

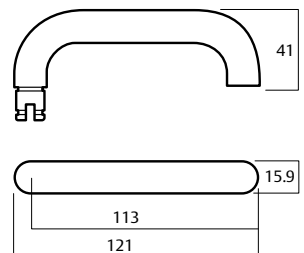

1370 Series Brass Door Handles

AS1428.1 Compliant Levers

Lever 74	
Length	120mm
Projection	53mm
Finger clearance	45mm

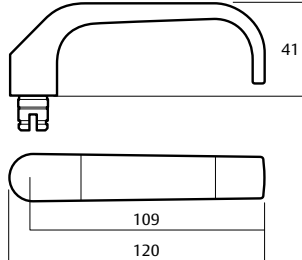

Lever 76	
Length	125mm
Projection	48.5mm
Finger clearance	40mm

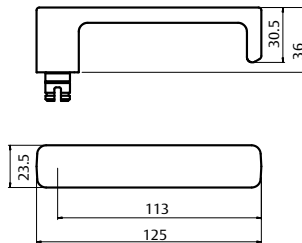

Lever 77	
Length	121mm
Projection	51mm
Finger clearance	48.3mm

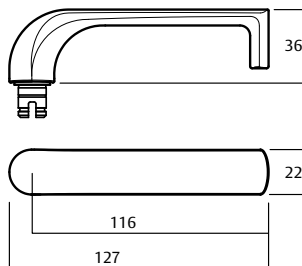

Lever 90	
Length	118.5mm
Projection	51.6mm
Finger clearance	44mm

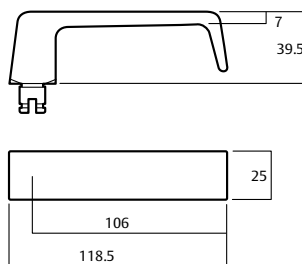

1370 Series Brass Door Handles

Non compliant lever/knob types

Lever 101

Length	130mm
Projection	48.5mm
Finger clearance	40mm

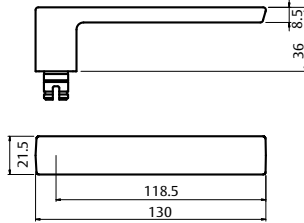

Lever 104

Length	133.8mm
Projection	57.5mm
Finger clearance	40mm

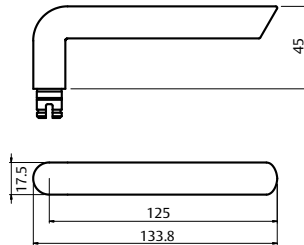

Lever 106

Length	130mm
Projection	48mm
Finger clearance	40mm

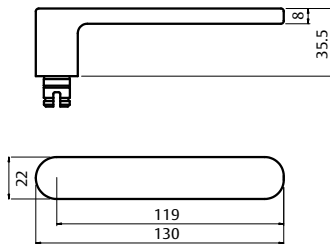

Lever 123

Length	130.5mm
Projection	59mm
Finger clearance	40mm

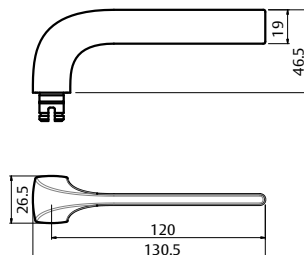

1370 Series Brass Door Handles

Non compliant lever/knob types

Lever 178

Length	130mm
Projection	63.6mm
Finger clearance	42mm

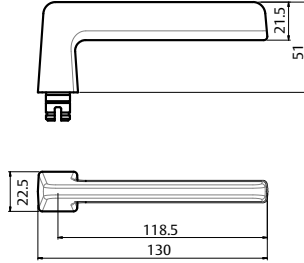

Lever 97

Length	120mm
Projection	50.5mm
Finger clearance	34.6mm

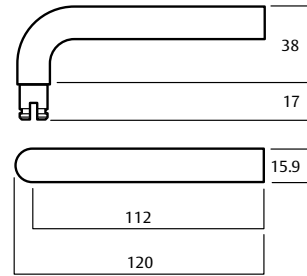

Knob 20

Diameter	50mm
Projection	73mm

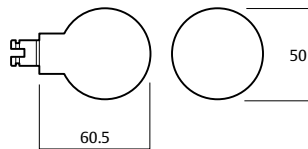

20 Knob can be used on outside rose only.

1370 Series Brass Door Handles

Handed Levers

Lever 41

Length	130mm
Projection	61.5mm
Finger clearance	40.5mm

* Lever is an asymmetrical design and therefore must be handed.

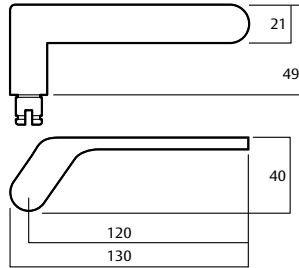

Lever 122

Length	130.5mm
Projection	59mm
Finger clearance	40mm

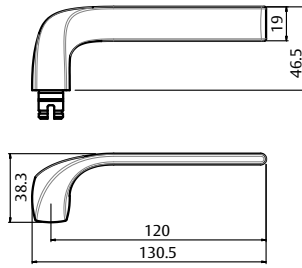

Lever 153

Length	120mm
Projection	70.6mm
Finger clearance	43mm

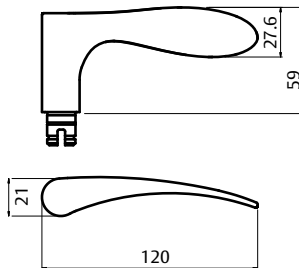

1370 Series Through Fix Escutcheon Kits

Through fix kits are optimised for use with Selector Series Mortice Locks. Supplied with two M4 64mm stainless screws for through fix installation.

Double Oval Cylinder Escutcheons Kit

Part Number 1376/6

Escutcheons supplied

Outside: Oval Cylinder Escutcheon

Inside: Oval Cylinder Escutcheon

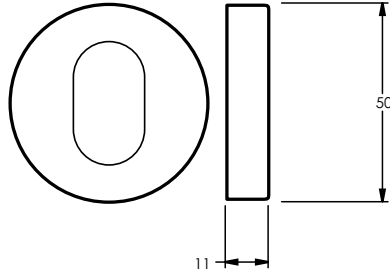

Outside

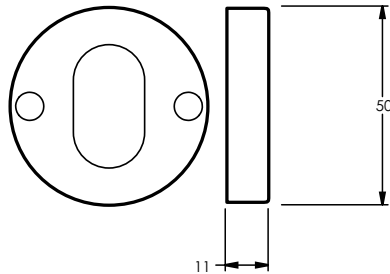

Inside

Oval Cylinder and Turnknob Escutcheons Kit

Part Number 1376/7N

Escutcheons supplied

Outside: Oval Cylinder Escutcheon

Inside: Turnknob Escutcheon

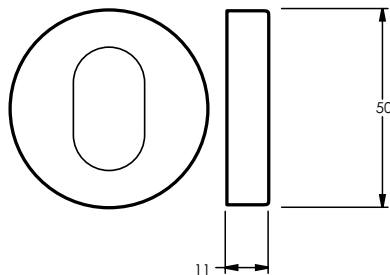

Outside

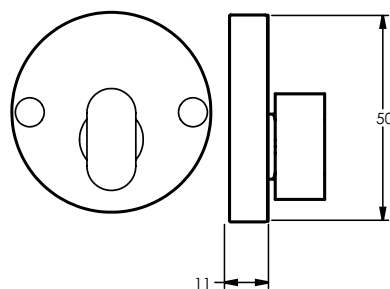

Inside

1370 Series Through Fix Escutcheon Kits

Privacy Indicating Emergency Turn and Disabled Accessible Turnknob Escutcheons Kit

Part Number 1378/9P

Escutcheons supplied

Outside: Privacy Indicating Emergency Turn Escutcheon

Inside: Privacy Indicating Disabled Accessible Turnknob Escutcheon

Door thickness: Suitable for 32 - 45mm doors.
Extended tail bars available for thicker doors.

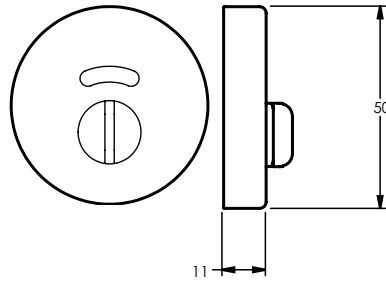

Outside

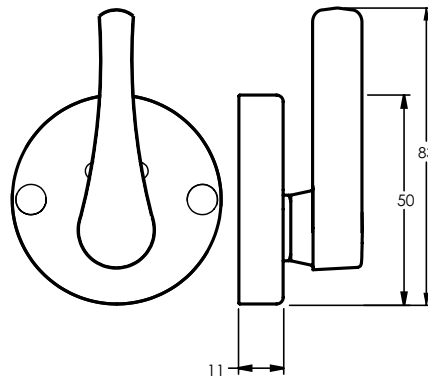

Inside

Note:
Common kit configurations are shown, for other kit variations please refer to the ordering procedure at the end of this section.

1370 Series Cylinder & Turn Escutcheons

Surface mounted escutcheons are optimised for use with Synergy Series Mortice Locks.

Oval Cylinder Escutcheon

Part Number 1376/E

Supplied with

- 2 x M4 x 65mm Stainless Steel Screws (SP1220-119)
- 1 x Allen Key (SP1366-14)
- 1 x Grub Screw M4 x 8mm (SPV0272 PBK)

(Replaces 1376)

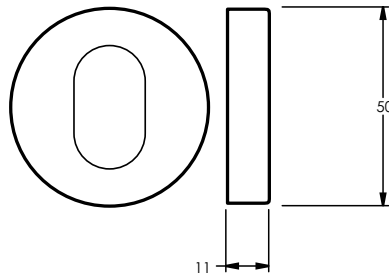

Turnknob Escutcheon

Part Number 1377/IN

Supplied with

- 2 x Short & 2 x Medium Wood Screws (SP1226-219)
- 1 x Short, Medium & Long Tail Bars and Spring (SP1227-219)
- 1 x Flat Tail Bar & Split Pin (SP1227-319)
- 1 x Instructions (1220-321)

(Replaces 1377)

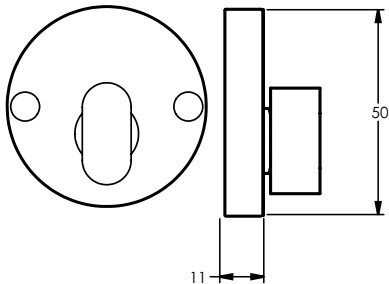

Privacy Indicating Turnknob Escutcheon

Part Number 1377/IP

Supplied with

- 2 x Short & 2 x Medium Wood Screws (SP1226-219)
- 1 x Short, Medium & Long Tail Bars and Spring (SP1227-219)
- 1 x Flat Tail Bar & Split Pin (SP1227-319)
- 1 x Instructions (1220-321)

(Replaces 1377P)

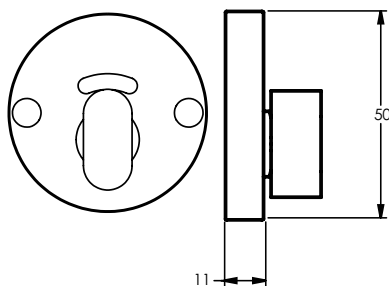

Emergency Turn Escutcheon

Part Number 1378/IN

Supplied with

- 2 x Short & 2 x Medium Wood Screws (SP1226-219)
- 1 x Emergency Tail Bar (SP1227-119)

(Replaces 1378)

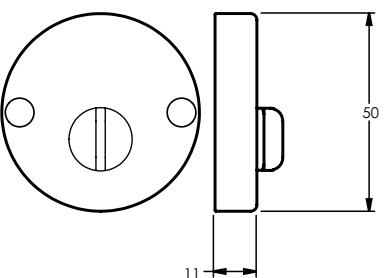

1370 Series Cylinder & Turn Escutcheons

Privacy Indicating Emergency Turn Escutcheon

Part Number 1378/IP

Supplied with

2 x Short & 2 x Medium Wood Screws (SP1226-219)
1 x Emergency Tail Bar (SP1227-119)

(Replaces 1378P)

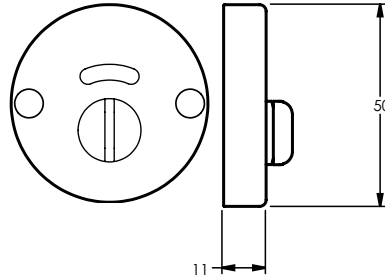

Disabled Accessible Turnknob

Part Number 1379/IN

Supplied with

2 x Short & 2 x Medium Wood Screws (SP1226-219)
1 x Short, Medium & Long Tail Bars and Spring (SP1227-219)
1 x Instructions (1220-321)

(Replaces 1377DT)

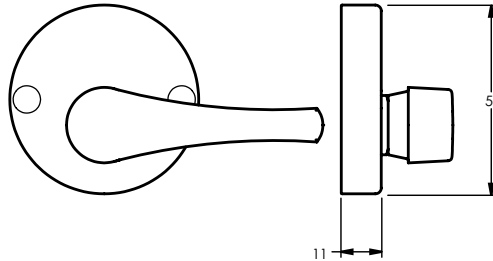

Disabled Accessible Privacy Indicating Turnknob

Part Number 1379/IP

Supplied with

2 x Short & 2 x Medium Wood Screws (SP1226-219)
1 x Short, Medium & Long Tail Bars and Spring (SP1227-219)
1 x Instructions (1220-321)

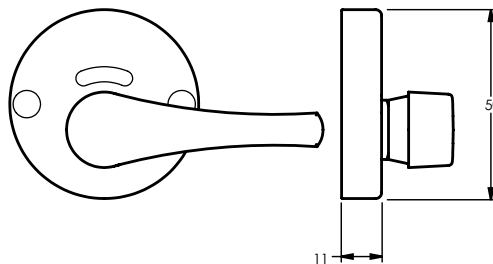

Door thickness: Suitable for 32 - 45mm doors.
Extended tail bars available for thicker doors.

1370 Series Ordering Procedure

Sample part number 1370/1371/41LCP is made up of several sections. Choose your product by selecting an option from each section.

Half Set

Note: Choose one rose only, exterior or interior.

Exterior Rose	Lever/ Knob	Handing	Finish
1370	41	L	CP

Full Set

Exterior Rose	Interior Rose	Lever/ Knob	Handing	Finish
1370	1371	41	L	CP

Exterior Rose Type	
Exterior Rose	1370
Exterior Blank Rose	1372
Exterior Fixed Rose	1374

Interior Rose Type	
Interior Rose	1371
Interior Blank Rose	1373
Interior Fixed Rose	1375

AS1428.1 Compliant Lever Types		
102	111	112
115	116	118
124	131	132
133	142	144
145	155	166
47	59	70
74	76	77
90		

Non compliant lever/knob types		
101	104	123
178	97	20

Handed Levers		
41	122	153

Handing	
Right Handed	R
Left Handed	L
NB: Omit if non-handed	

Finish	
Satin Chrome Brushed	SC
Chrome Plate	CP
Polished Brass	PB
Polyester Powdercoat	PC

Non - Standard Finishes	
Polished Brass Unlacquered	BU
Satin Brass	SB
Satin Brass Unlacquered	SBU
Architectural Bronze	AZ
Architectural Bronze Unlacquered	AU
Antique Copper	AC
Oil Rubbed Bronze	ORB

Note: Refer to the decorative finishes section at the end of this catalogue for images of the full metal finishes and powder coat colour range available.

1370 Series Ordering Procedure

Escutcheon Kits

Through fix kits are optimised for use with Selector Series Mortice Locks. Supplied with two M4 64mm stainless screws for through fix installation.

Sample part number 1376/9NSC is made up of several sections. The description of this part number is an oval cylinder and disabled accessible turnknob escutcheon kit.

Exterior Function	Interior Rose	Privacy Indicator	Finish
1376	9	N	SC

Exterior Function	
Oval Cylinder	1376
Emergency Turn	1378

Notes:
Order 1376/E if only one oval cylinder escutcheon is required. A grub screw will be supplied to allow for concealed fixing.

1378/6 Kit is not applicable.

Interior Function	
Oval Cylinder	6
Oval Turnknob	7
Disabled Accessible Turnknob	9

Privacy Indicator	
Oval Cylinder	-
Non Indicating	N
Privacy Indicating	P

Note:
Privacy indicator applies for both exterior and interior functions.

Finish	
Satin Chrome Brushed	SC
Chrome Plate	CP
Polished Brass	PB
Polyester Powdercoat	PC

Special Finishes	
Polished Brass Unlacquered	BU
Satin Brass	SB
Satin Brass Unlacquered	SBU
Architectural Bronze	AZ
Architectural Bronze Unlacquered	AU
Antique Copper	AC
Oil Rubbed Bronze	ORB

Note: Refer to the decorative finishes section at the end of this catalogue for images of the full metal finishes and powder coat colour range available.

Refer to page 88 for reference guide.

1370 Series Ordering Procedure

Surface Mounted Escutcheons

Surface mounted escutcheons are optimised for use with Synergy Series Mortice Locks.

Supplied with wood screws to suit surface mounting on either side of the door.

Escutcheon Type	Fixing	Privacy Indicator	Finish
1379	I	P	SC

Escutcheon Type	
Oval Cylinder	1376
Oval Turn	1377
Emergency Turn	1378
Disabled Accessible Turn	1379

Fixing	
Wood Screw Surface Fixing	I
Grub Screw Concealed Fixing	E*

Note:
*Only applicable when ordering with 1376 Oval Cylinder Escutcheon. The 1376/E will be supplied with a grub screw to allow for concealed fixing.

Privacy Indicator	
Oval Cylinder	-
Non Indicating	N
Privacy Indicating	P

Finish	
Satin Chrome Brushed	SC
Chrome Plate	CP
Polished Brass	PB
Polyester Powdercoat	PC

Special Finishes	
Polished Brass Unlacquered	BU
Satin Brass	SB
Satin Brass Unlacquered	SBU
Architectural Bronze	AZ
Architectural Bronze Unlacquered	AU
Antique Copper	AC
Oil Rubbed Bronze	ORB

Note: Refer to the decorative finishes section at the end of this catalogue for images of the full metal finishes and powder coat colour range available.











Refer to page 89 for reference guide.

1370 Series Reference Guide

Lockwood Brass Turns and Cylinder Escutcheons

Fitting: Through Fix Mounting

Optimized for Selector 3770 Series Mortice Locks









1370 Series Kits									
Image	Part Number	Handed	Kit Description		Mortice Lock/Bolt Compatibility				
			Exterior Function	Interior Function	Synergy 3570 Locks	Selector 3770 Locks	PT Mortice Locks	6260 Privacy Bolt	
	1376/6SC	No	Oval Cylinder Escutcheon	Oval Cylinder Escutcheon		✓	✓		
	1376/7NSC	No	Oval Cylinder Escutcheon	Oval Turnknob		✓	✓		
	1376/7PSC	No	Oval Cylinder Escutcheon	Privacy Indicating Oval Turnknob		✓	✓		
	1376/9NSC	No	Oval Cylinder Escutcheon	Disabled Accessible Turnknob		✓	✓		
	1376/9PSC	No	Oval Cylinder Escutcheon	Privacy Indicating Disabled Accessible Turnknob		✓	✓		
	1378/7NSC	No	Emergency Turn	Oval Turnknob		✓	✓	✓	
	1378/7PSC	No	Privacy Indicating Emergency Turn	Privacy Indicating Oval Turnknob		✓	✓	✓	
	1378P/7NSC	No	Privacy Indicating Emergency Turn	Oval Turnknob		✓	✓	✓	
	1378/9NSC	No	Emergency Turn	Disabled Accessible Turnknob		✓	✓	✓	
	1378/9PSC	No	Privacy Indicating Emergency Turn	Privacy Indicating Disabled Accessible Turnknob		✓	✓	✓	
	1378P/9NSC	No	Privacy Indicating Emergency Turn	Disabled Accessible Turnknob		✓	✓	✓	

1370 Series Reference Guide

Lockwood Brass Turns and Cylinder Escutcheons

Fitting: Surface Mounting

Optimized for Synergy 3570 Series Mortice Locks

1370 Series Surface Mounted Escutcheons				Mortice Lock/Bolt Compatibility				Replaced Codes	
Image	Part Number	Handed	Description	Synergy 3570 Locks	Selector 3770 Locks	PT Mortice Locks	6260 Privacy Bolt	Previous Surface Mounted Turns	Previous Pentagon External Turns
	1376/ESC	No	Oval Cylinder Escutcheon	✓	✓	✓		1376SC	1376/ESC
	1377/IPSC	No	Privacy Indicating Oval Turnknob Escutcheon	✓	✓	✓	✓	1377PSC	1377/EPSC
	1377/INSC	No	Non-Indicating Oval Turnknob Escutcheon	✓	✓	✓	✓	1377SC	1377/ENSC
	1378/INSC	No	Non-Indicating Emergency Turn Escutcheon	✓	✓	✓	✓	1378SC	1378/ENSC
	1378/IPSC	No	Privacy Indicating Emergency Turn Escutcheon	✓	✓	✓	✓	1378PSC	1378/EPSC
	1379/INSC	No	Non-Indicating Disabled Accessible Turnknob Escutcheon	✓	✓	✓	✓	1377DT	1379/ENSC
	1379/IPSC	No	Privacy Indicating Disabled Accessible Turnknob Escutcheon	✓	✓	✓	✓		1379/EPSC
	1376ESC	No	Euro Profile Cylinder Escutcheon	✓	✓	✓		-	-

260 Series Door Handles



The 260 Series door furniture has a 55mm round rose. Concealed fixed plates have studs with internal threads located on the rose, visible roses have corresponding countersunk holes and are fixed back to back through the door.

Application

Designed for use with Lockwood 3770 and 3570 Series Mortice Latches and with 5260 Tubular Latches.

Product Details

Dimensions	Lever Rose 55 x 3mm - aluminium 55 x 2mm - stainless steel and brass Escutcheon Rose
	50 x 3mm - aluminium 50 x 2mm - stainless steel and brass

Materials Aluminium, stainless steel or brass

Door Thickness	For use with 3570 Series Mortice Latches: Door thickness 35 to 45mm
	For use with 5260 Tubular Latches: Door thickness 37-45mm (Extended screws and packing plates available for installation on thicker and thinner doors.)

Finishes Standard Stainless Steel (SS)

Finishes Non Standard Polished Stainless Steel (PS)
Powdercoat (PC)

Standards and Compliance



260 Series has been successfully tested up to 4 hours with a fire rated Lockwood mortice lock on fire door assemblies (depending on type of doorset) in accordance with Australian Standard AS1905.1:2005, Fire Resistant Doorsets.

D3

260 Series lever sets have been successfully tested to conform with Level D8 (500,000 cycles) under Australian Standard AS4145.2-2008, Locksets and hardware for doors and windows.



Anti-Corrosion



260 Series includes levers and turns (as shown) that meet the requirements of AS1428.1-2009, Design for access and mobility.

Lockwood Artefact Door Furniture is designed, assembled and customised in Australia to suit the requirements of the Australian Market.

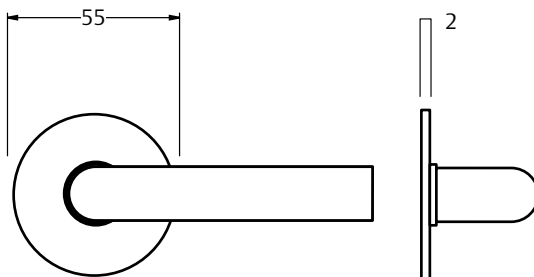

SS/Brass

260 Series Door Handle Functions

Rose Furniture 55mm Diameter

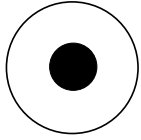

260 Operable

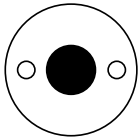

261 Operable

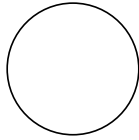

262 Blank

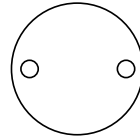

263 Blank

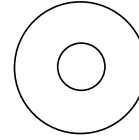

264 Fixed

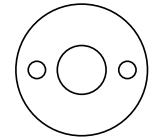

265 Fixed

Escutcheon Furniture 50mm Diameter

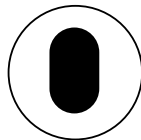

280

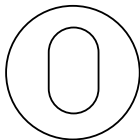

281

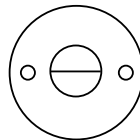

282

Functions Legend

Cylinder Hole



Turnknob



Emergency Turn



260SQ Series Square Door Rose Door Handles



The 260SQ Series door furniture has a 55mm x 2mm square rose. Concealed fixed plates have studs with internal threads located on the rose, visible roses have corresponding countersunk holes and are fixed back to back through the door.

Application

Designed for use with Lockwood 3770 and 3570 Series Mortice Latches and with 5260 Tubular Latches.

Product Details

Dimensions	Lever Rose 55 x 2mm - stainless steel
	Escutcheon Rose 50 x 2mm - stainless steel
Materials	Stainless steel only
Door Thickness	For use with 3570 Series Mortice Latches: Door thickness 35 to 45mm
	For use with 5260 Tubular Latches: Door thickness 37-45mm (Extended screws and packing plates available for installation on thicker and thinner doors.)

Finishes Standard Stainless Steel (SS)

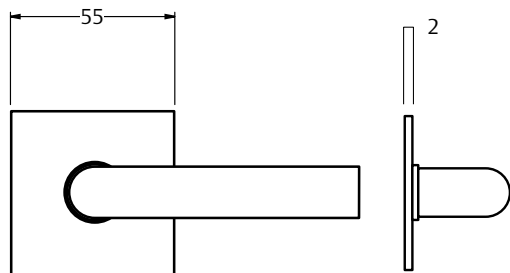

Stainless Steel

Standards and Compliance



260SQ Series has been successfully tested up to 4 hours with a fire rated Lockwood mortice lock on fire door assemblies (depending on type of doorset) in accordance with Australian Standard AS1905.1:2005, Fire Resistant Doorsets.

D3

260SQ Series lever sets have been successfully tested to conform with Level D8 (500,000 cycles) under Australian Standard AS4145.2-2008, Locksets and hardware for doors and windows.



Anti-Corrosion



260SQ Series includes levers and turns (as shown) that meet the requirements of AS1428.1-2009, Design for access and mobility.

Lockwood Artefact Door Furniture is designed, assembled and customised in Australia to suit the requirements of the Australian Market.

260SQ Series Square Door Rose Door Handles

Levers and Knob to Suit

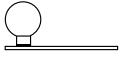

20*1

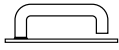

96

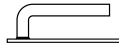

98

Square Furniture 55 x 55mm

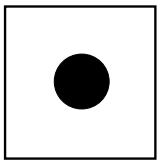

260 Operable

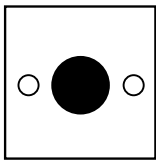

261 Operable



262 Blank

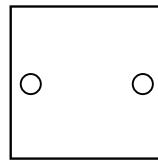

263 Blank

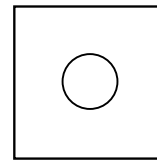

264 Fixed

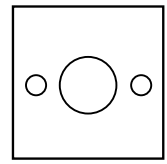

265 Fixed

Square Escutcheon Furniture 50 x 50mm

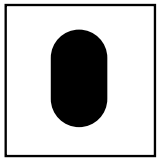

280SQ

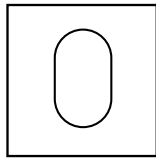

281SQ

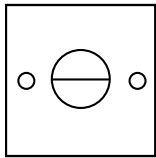

282SQ

Functions Legend

Cylinder Hole



Turnknob



Emergency Turn



260 Series Ordering Procedure

Ordering Procedure

Sample part number 260/261/SQ96SS is made up of several sections. Choose your product by selecting an option from each section.

Half Set

For example:

Exterior Rose	Lever/ Knob	Handing	Finish
260	SQ	96	SS

Note: Choose one rose only, exterior or interior.

260 Series

Exterior Rose	Interior Rose	Rose Shape	Lever/ Knob	Handing	Finish
260	261	-	96	L	SS

Exterior Rose Type

Exterior Rose	260
Exterior Blank Rose	262
Exterior Round Rose -Fixed Rose	264

Interior Rose Type

Interior Rose	261
Interior Blank Rose	263
Interior Fixed Rose	265

Rose Shape

Round	-
Square	SQ

AS1428.1 Compliant Lever Types

102	111	112
115	116	118
124	131	132
133	142	144
145	155	166
47	59	70
74	76	77
90		

Non compliant lever/knob types

101	104	123
178	97	20

Handed Levers

Brass Levers

41	122	153
----	-----	-----

* Levers 65 and 85 not available in PS or PB

Handing

Left Handed	L
Right Handed	R

Finish - 260 Series

Satin Stainless Steel	SS
Powdercoat	PC
Polished Stainless Steel	PS
Aluminium	NT
Polished Brass	PB

Finish - 260SQ Series

Satin Stainless Steel	SS
-----------------------	----

Velocity® Series Large Rose Door Furniture



The Velocity Series is a stylish range of door furniture suitable for use in residential dwellings.

Designed to suit common door preparations in the Australian market, Velocity is ideal for both new and retrofit applications.

Retrofitable

Fits majority of doors with 54mm hole.

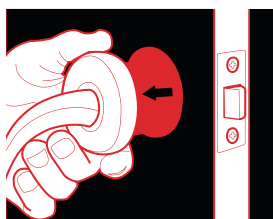

1 Align 2 Twist 3 Tighten



Features and Specifications

- All fixings are concealed beneath a removable rose trim providing a crisp and clean presentation desired by the discerning home owner
- Simple twist and tighten fixing method and lever set pre-assembly allows for super easy and super fast installation
- Available in a choice of six lever designs and three finishes
- The rose fits 50mm or 54mm diameter holes making it suitable for retrofit and common door preparations
- Designed in Australia for the specific needs of the Australian market

Product Details

Rose Dimensions 63mm by 12.5mm.

Materials All Velocity levers and roses are made from solid zinc die-cast with steel rose trims.

Latches Passage sets are available both with and without a 60mm backset tubular latch. Privacy sets are supplied with a 60mm backset privacy latch which includes an activating pin for the inside of the door and an external emergency release function. The latch is automatically released when the internal handle is operated and is easily adapted for both open in and open out applications. All latches are supplied with industry standard "D" strikes.

Door Thickness 32mm to 45mm hinged doors

Finishes Satin Chrome Brushed (SC)
Satin Chrome Pearl (SP)
Chrome Plate (CP)

Standards and Compliance

D8

VEL Series lever sets have been successfully tested to conform with Level D8 (500,000 cycles) under Australian Standard AS4145.2-2008, Locksets and hardware for doors and windows.



VEL Series in brushed satin chrome finish has been successfully tested to conform with Level C10 (1000 hours) under Australian Standard AS4145.2-2008, Locksets and hardware for doors and windows.

Not suited to coastal applications

Velocity® Series Large Rose Door Handles

Summit® – Lever 1

Length	122mm
Projection	56.5mm
Finger Clearance	34.5mm

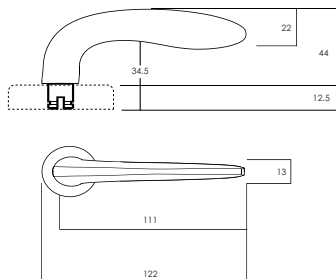

Spire® – Lever 2

Length	124mm
Projection	57.5mm
Finger Clearance	44.5mm

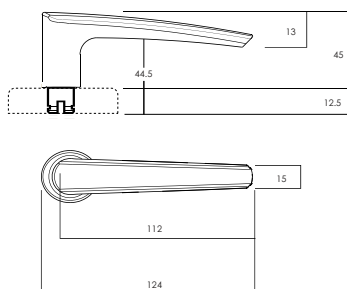

Element™ – Lever 3

Length	122mm
Projection	54.5mm
Finger Clearance	47.5mm

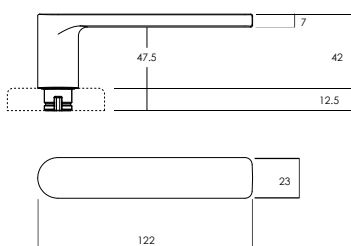

Glide™ – Lever 4

Length	121mm
Projection	56.5mm
Finger Clearance	33.5mm

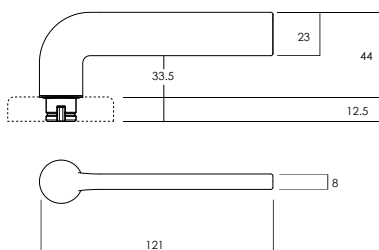

Velocity® Series Large Rose Door Handles

Hakea® - Lever 28

Length	121mm
Projection	63mm
Finger Clearance	43mm

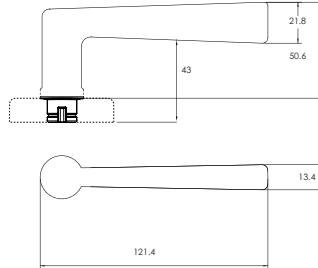

Saltbush® - Lever 34

Length	120mm
Projection	64mm
Finger Clearance	43.5mm

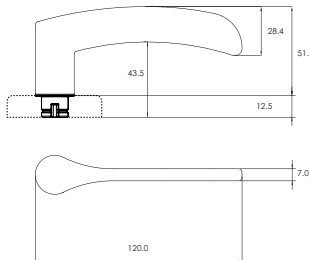

Velocity® Series Large Rose Accessories

Square Rose Passage Trim

Part Number	VES1-TRIM
Height	65mm
Depth	12.5mm
Quantity	Pack of 2

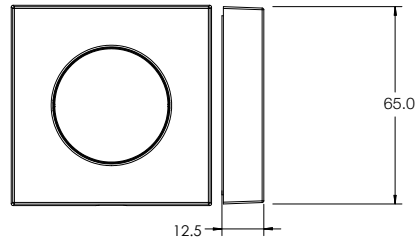

Square Rose Privacy Trim

Part Number	VES2-TRIM
Height	65mm
Depth	12.5mm
Quantity	Pack of 2

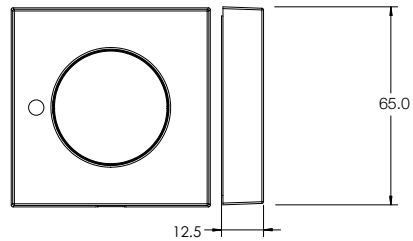

Velocity® Series Large Rose Ordering Procedure

Ordering Procedure

Sample part number VEL1/L1/SC is made up of several sections. Choose your product by selecting an option from each section.

Velocity® 63mm Series

Exterior Rose	Function	Lever Type	Latch	Finish	Packaging
VEL	1	L1		SC	

Rose Type	Levers	Latch	Finish	Packaging
63mm Round Rose VEL	Summit® L1	No latch (Passage only) NL	Satin Chrome Brushed SC	Trade -
	Spire® L2		Satin Chrome Pearl SP	Display DP
	Element™ L3		Chrome Plate CP	
	Glide™ L4		Matt Black MBK*	
	Hakea® 28		*MBK finish on Velocity Large Rose is only available with Lever 3	
	Saltbush® 34			

Function	
Passage	1
Privacy	2
Dummy Half	3

Square Rose Ordering Procedure

Function	Satin Chrome Finish	Chrome Plate Finish	Satin Pearl Finish	Matt Black Finish
Passage Lever Set Dummy Half Set	VES1-TRIMSC	VES1-TRIMCP	VES1-TRIMSP	VES1-TRIMMBK
Privacy Lever Set	VES2-TRIMSC	VES2-TRIMCP	VES2-TRIMSP	VES2TRIM-MBK

Square Rose Lever Sets are ordered in the same manner as Round Rose Lever Sets above with the addition of a Square Rose Trim Pack. For example a Passage Lever Set, Lever 4 in Satin Chrome will require both VEL1/L4SC and VES1-TRIMSC.

Velocity® Series Small Rose Door Handles



The Velocity 55mm Series is a stylish range of door furniture suitable for both residential and semi commercial applications. Designed primarily for new installation on timber doors, the range incorporates functionality for use with Mortice Locks in addition to Passage, Privacy and Dummy Levers.

Installation

Suits door preparations up to 45mm.

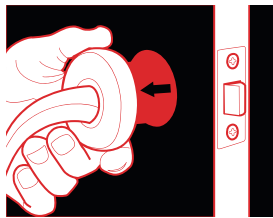

1 **Align** 2 **Twist** 3 **Tighten**



Features and Specifications

- All fixings are concealed beneath a removable rose trim providing an aesthetically appealing installation.
- Simple twist and tighten fixing method and pre-assembled lever sets allow for super easy and fast installation.
- Lever range includes two AS1428.1 compliant levers and six designer levers.
- Accessories include AS1428.1 compliant turn, standard turn and privacy indicating emergency turns.
- The 55mm rose suits up to 45mm door preparations commonly used with mortice locks or latches.
- Designed in Australia for the specific needs of the Australian market.

Product Details

Rose Dimensions	55mm by 12.5mm - Round Rose 58mm by 12.5mm - Square Rose
Materials	All Velocity 55mm levers and roses are made from solid zinc die-cast.
Latches	Passage sets are available with a 60mm backset tubular latch. Privacy sets are supplied with a 60mm backset privacy latch which includes a locking pin for the inside of the door and an external emergency release function. The latch is automatically released when the internal handle is operated and is easily adapted for both open in and open out applications. All latches are supplied with industry standard "D" strikes.
Door Thickness	32mm to 45mm hinged doors
Finishes	Satin Chrome Brushed (SC) Chrome Plate (CP) Satin Pearl (SP) Display Pack Range Only

Standards and Compliance



Successfully tested up to 2 hours on fire door assemblies in accordance with the Australian Standard AS1905.1 2005 - Part 1: Fire Resistant Doorsets

D8

VEL Series lever sets have been successfully tested to conform with Level D8 (500,000 cycles) under Australian Standard AS4145.2-2008, Locksets and hardware for doors and windows.



VEL Series in brushed satin chrome finish has been successfully tested to conform with Level C10 (1000 hours) under Australian Standard AS4145.2-2008, Locksets and hardware for doors and windows.



AS1428.1 Compliance. The range includes AS1428.1 compliant levers and turns as shown.

Velocity® Series Small Rose Door Handles

AS1428.1 Compliant Levers

Accession® - Lever 5

Length 121mm

Projection 56.5mm

Finger Clearance 38.4mm



Disabled Accessible
AS1428.1

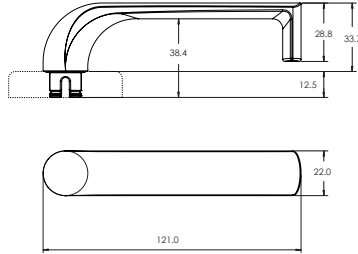

Dianella™ - Lever 8

Length 121mm

Projection 51mm

Finger Clearance 38mm



Disabled Accessible
AS1428.1

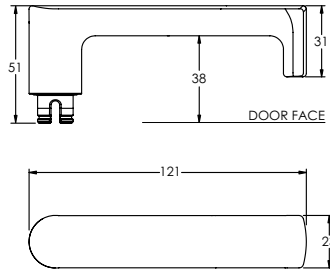

Gidgee® - Lever 37

Length 120mm

Projection 64mm

Finger Clearance 38.5mm



Disabled Accessible
AS1428.1

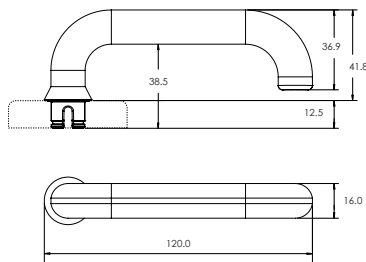

Standard Levers

Element™ - Lever 3

Length 122mm

Projection 54.5mm

Finger Clearance 47.5mm

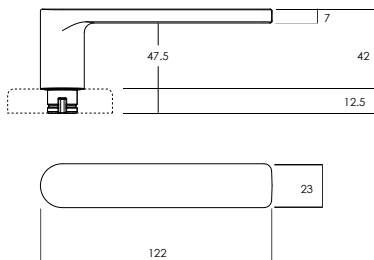

Velocity® Series Small Rose Door Handles

Standard Levers

Hakea® - Lever 28

Length	121mm
Projection	63mm
Finger Clearance	43mm

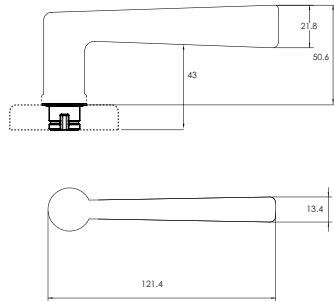

Acacia® - Lever 29A

Length	120mm
Projection	64mm
Finger Clearance	41.5mm

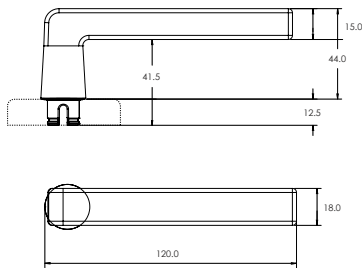

Saltbush® - Lever 34

Length	120mm
Projection	64mm
Finger Clearance	43.5mm

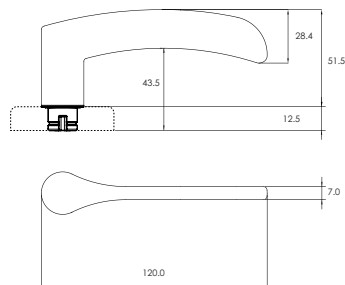

Velocity® Series Small Round Rose Accessories

Euro Cylinder Escutcheon

Part Number	VSR5
Height	55mm
Depth	12.5mm

Supplied with
2x Wood Screws

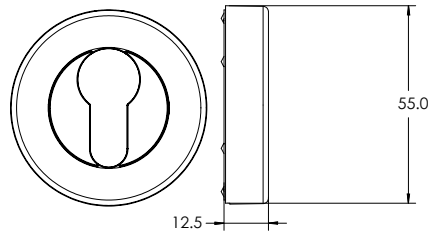

Oval Cylinder Escutcheon

Part Number	VSR6
Height	55mm
Depth	12.5mm

Supplied with
2x Wood Screws

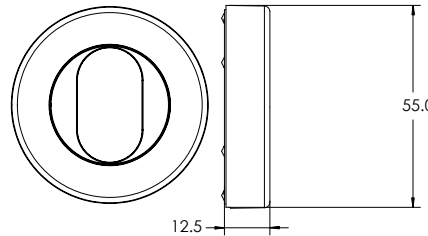

Standard Turnknob

Part Number	VSR7
Height	55mm
Depth	12.5mm
Handing	Not required

Supplied with
2x Wood Screws
1x Short Tail Bar
1x Medium Tail Bar
1x Tail Bar Spring
1x Instructions (1220-321)

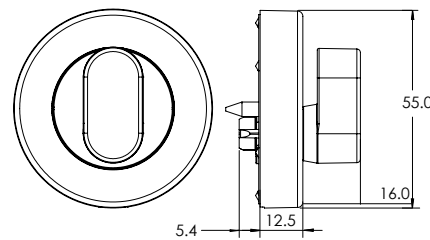

Privacy Indicating Emergency Turn

Part Number	VSR8
Height	55mm
Depth	12.5mm

Supplied with
2x Wood Screws
1x Emergency Tail Bar
1x Instructions (1220-321)

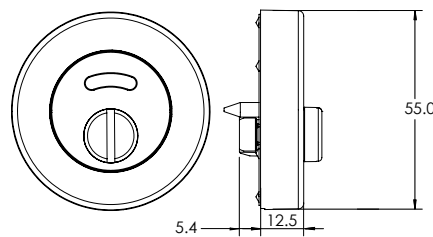

Velocity® Series Small Round Rose Accessories

Disabled Accessible Turnknob

Part Number	VSR9
Height	55mm
Depth	12.5mm
Turn Snib Length	52mm
Handing	Site handable

Supplied with

- 2x Wood Screws
- 1x Tail Bar (short)
- 1x Tail Bar (medium)
- 1x Tail Bar Spring
- 1x Instructions (1220-321)

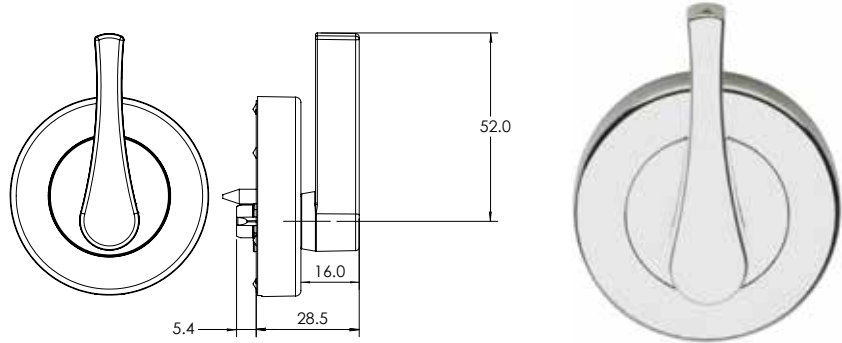

*VSR9 is not compatible with Selector series mortice locks.

Round Rose Passage Trim

Part Number	VSR1-TRIM
Height	55mm
Depth	12.5mm
Quantity	Pack of 2

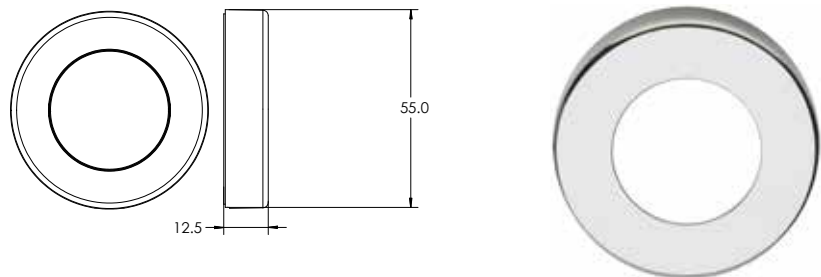

Round Rose Privacy Trim

Part Number	VSR2-TRIM
Height	55mm
Depth	12.5mm
Quantity	Pack of 2

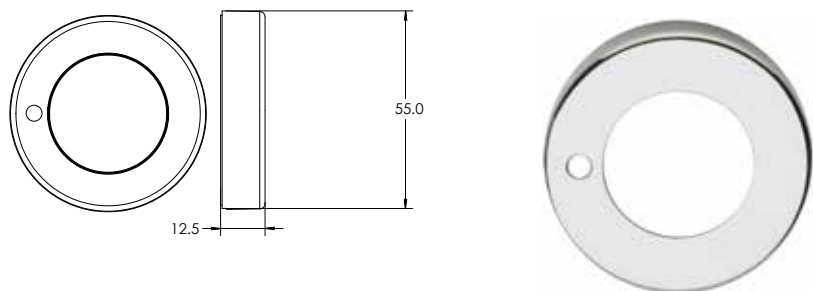

Velocity® Series Small Square Rose Accessories

Euro Cylinder Escutcheon

Part Number	VSS5
Height	58mm
Depth	12.5mm

Supplied with
2x Wood Screws

Note: Please ensure clearance between lever trim and escutcheons when used with European Mortice Locks.

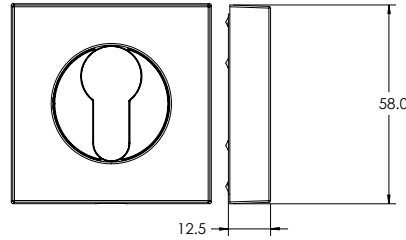

Oval Cylinder Escutcheon

Part Number	VSS6
Height	58mm
Depth	12.5mm

Supplied with
2x Wood Screws

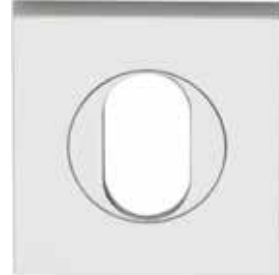
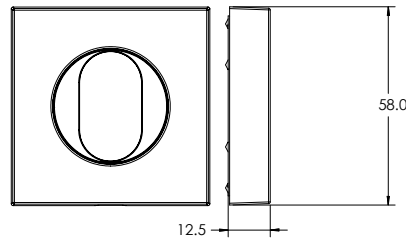

Standard Turn Snib

Part Number	VSS7
Height	58mm
Depth	12.5mm
Handing	Not required

Supplied with
2x Wood Screws
1x Short Tail Bar
1x Medium Tail Bar
1x Tail Bar Spring
1x Instructions (1220-321)

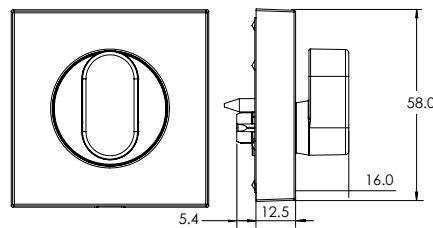

Emergency Indicating Turn

Part Number	VSS8
Height	58mm
Depth	12.5mm
Handing	Not required

Supplied with
2x Wood Screws
1x Emergency Tail Bar
1x Instructions (1220-321)

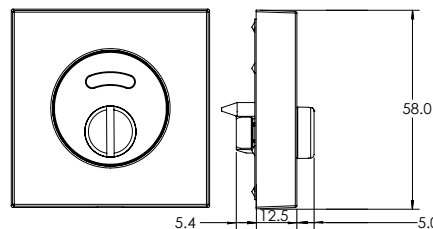

Velocity® Series Small Square Rose Accessories

Disabled Accessible Turn Snib

Part Number	VSS9
Height	58mm
Depth	12.5mm
Turn Snib Length	52mm
Handing	Site handable

Supplied with

- 2x Wood Screws
- 1x Tail Bar (short)
- 1x Tail Bar (medium)
- 1x Tail Bar Spring
- 1x Instructions (1220-321)

*VSS9 is not compatible with Selector series mortice locks.

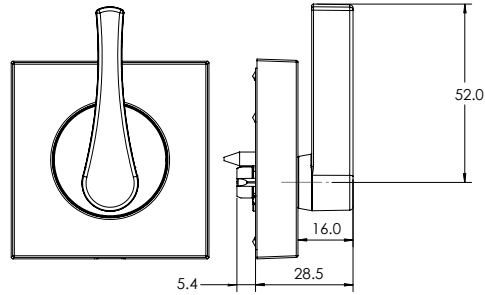

Square Rose Passage Trim

Part Number	VSS1-TRIM
Height	58mm
Depth	12.5mm
Quantity	Pack of 2

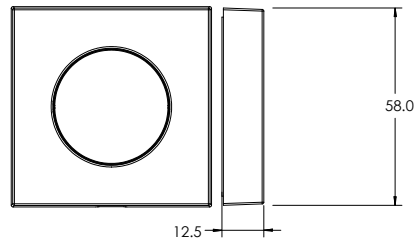

Square Rose Privacy Trim

Part Number	VSS2-TRIM
Height	58mm
Depth	12.5mm
Quantity	Pack of 2

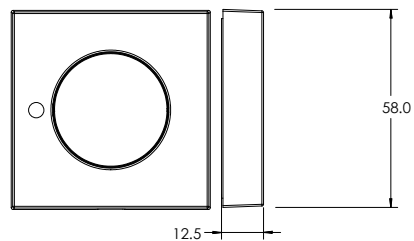

Velocity® Series Rose Door Handles

Sample part number VSR1/L3SC is made up of several sections. Choose your product by selecting an option from each section.

Velocity® Small Rose Series - Trade Pack Range

Exterior Rose	Function	Lever Types	Finish				
VSR	1	L3	SC				
Rose Type	Function	Levers	Finish	Packaging			
Velocity 55mm Round Rose	Mortice 0	Summit® L1	Satin Chrome Brushed SC	Trade Pack			
Velocity 58mm Square Rose	Passage 1	Element™ L3	Chrome Plate CP				
	Privacy 2	Glide™ L4	Matt Black MBK				
	Dummy Half 3	Hakea® 28					
	Euro Escutcheon 5	Acacia® 29A					
	Oval Escutcheon 6	Saltbush® 34					
	Standard Turnknob 7	AS1428.1 Compliant Levers					
	Privacy Indicating Emergency Turn 8	Accession® L5					
	Disabled Accessible Turnknob 9	Dianella™ L8					
		Gidgee® 37					

Note: Mortice, Passage, Privacy and Dummy Half Lever Sets only available in Round Rose. See below for ordering procedure

Velocity® Small Rose Series - Display Pack Range

Rose Type	Function	Lever Types	Finish	Packaging		
VSR	1	L3	SC	DP		
Rose Type	Function	Levers	Finish	Packaging		
Velocity 55mm Round Rose	Passage 1	Summit® L1	Satin Chrome Pearl SP	Display	DP	
	Privacy 2	Spire® L2	Chrome Plate CP			
		Element™ L3	Satin Chrome Brushed SC			
		Glide™ L4				

Square Rose Ordering Procedure

Function	Satin Chrome Finish	Chrome Plate Finish	Satin Pearl Finish	Matt Black Finish
Mortice Lever Set				
Passage Lever Set	VSS1-TRIMSC	VSS1-TRIMCP	VSS1-TRIMSP	VSS1-TRIMMBK
Dummy Half Set				
Privacy Lever Set	VSS2-TRIMSC	VSS2-TRIMCP	VSS2-TRIMSP	VSS2-TRIMMBK

Square Rose Lever Sets are ordered in the same manner as Round Rose Lever Sets above with the addition of a Square Rose Trim Pack. For example a Mortice Lever Set, Lever 5 in Satin Chrome will require both VSR0/L5SC and VSS1-TRIMSC.

Vivid® Collection Internal Door Leversets



The Lockwood Vivid® Collection is a stylish range of internal door furniture suitable for use in residential dwellings.

The Vivid® Collection includes three different internal leversets: the Privacy Leverset, Passage Leverset and Half Dummy Lever.

The Privacy Leverset comes with Privacy Tubular Latches and an accessory pack (including spindles, springs, mounting wood screws, through fix screws, privacy pin and a pointed tool), while the Passage Leverset comes with tubular latches and a different accessory pack (including spindles, springs, mounting wood screws, and through fix screws), specifically designed for passage door applications. The Half Dummy Lever comes with a fixed lever and timber mounting screws to be used on cupboard or wardrobe doors.



Features and Specifications

- All fixings are concealed beneath a removable rose trim providing an aesthetically appealing installation.
- Lever range includes two AS1428.1 compliant levers
- The 54mm rose suits up to 45mm door preparations.

Product Details

Rose Dimensions	54mm diameter x 12mm
Materials	All visible surfaces 304 stainless steel with durable PVD surface treatment.
Latches	Passage sets are available with a 60mm backset tubular latch. Privacy sets are supplied with a 60mm backset privacy latch which includes a privacy pin for the inside of the door and an external emergency release function. The latch is automatically released when the internal handle is operated and is easily adapted for both open in and open out applications. All latches are supplied with industry standard "T" strikes box.
Door Thickness	32-45mm hinged door for Privacy set 32-45mm hinged door for Passage set
Finishes	PVD Satin Brass (SB), PVD Satin Gun Metal (GM), PVD Satin Bronze (BZ)

Standards and Compliance

D7	Tested to AS4145.2 2008 for Durability passing D7 - 300,000 cycles.
	Tested to AS4145.2 2008 for Neutral Salt Spray, passing C6 - 168 hours.
	Vivid® Collection includes levers (as shown) that meet the requirements of AS1428.1-2009, Designed for access and mobility.

Vivid® Collection Internal Door Leversets

Lever 1 - Passage

Part Number VIV1/V1SBPVD
VIV1/V1GMPVD
VIV1/V1BZPVD

Length 127mm

Projection 53mm



Disabled Accessible
AS1428.1 Compliant

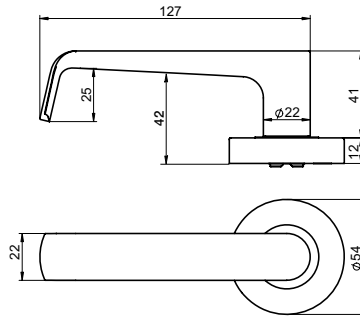

Lever 1 - Privacy

Part Number VIV2/V1SBPVD
VIV2/V1GMPVD
VIV2/V1BZPVD

Length 127mm

Projection 53mm



Disabled Accessible
AS1428.1 Compliant

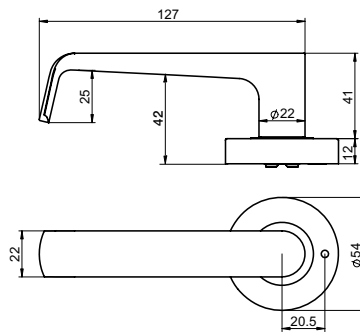

Lever 1 - Dummy

Part Number VIV3/V1BZPVD
VIV3/V1GMPVD
VIV3/V1SBPVD

Length 127mm

Projection 53mm



Disabled Accessible
AS1428.1 Compliant

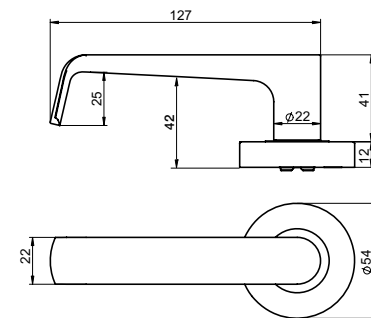

Vivid® Collection Internal Door Leversets

Lever 2 - Passage

Part Number VIV1/V2SBPVD
VIV1/V2GMPVD
VIV1/V2BZPVD

Length 140mm

Projection 60mm



Disabled Accessible
AS1428.1 Compliant

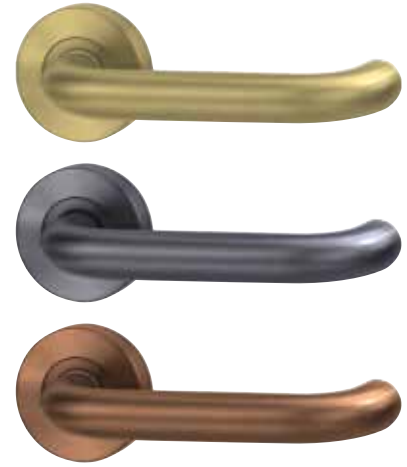
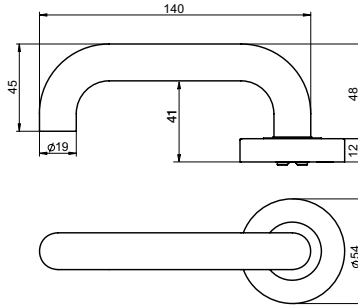

Lever 2 - Privacy

Part Number VIV2/V2SBPVD
VIV2/V2GMPVD
VIV2/V2BZPVD

Length 140mm

Projection 60mm



Disabled Accessible
AS1428.1 Compliant

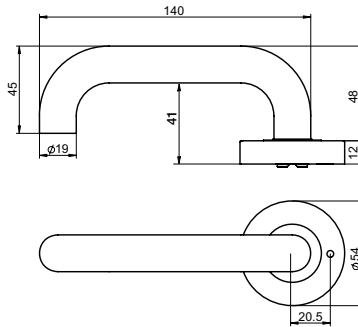

Lever 2 - Dummy

Part Number VIV3/V2SBPVD
VIV3/V2GMPVD
VIV3/V2BZPVD

Length 140mm

Projection 60mm



Disabled Accessible
AS1428.1 Compliant

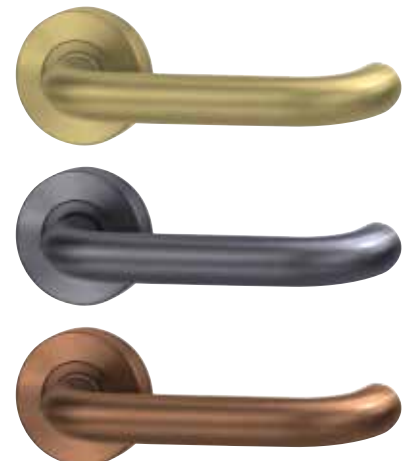
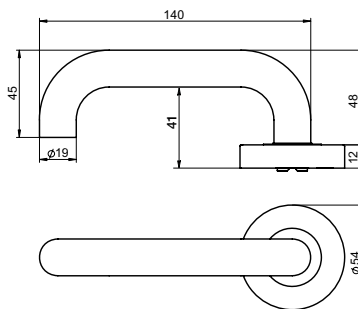

Vivid® Collection Internal Door Leversets

Lever 3 - Passage

Part Number VIV1/V3SBPVD
VIV1/V3GMPVD
VIV1/V3BZPVD

Length 130mm

Projection 57mm

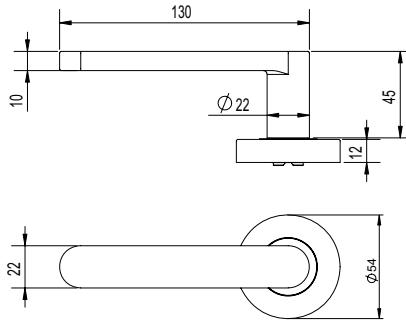

Lever 3 - Privacy

Part Number VIV2/V3SBPVD
VIV2/V3GMPVD
VIV2/V3BZPVD

Length 130mm

Projection 57mm

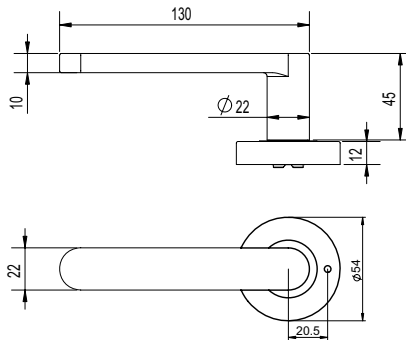

Lever 3 - Dummy

Part Number VIV3/V3SBPVD
VIV3/V3GMPVD
VIV3/V3BZPVD

Length 130mm

Projection 57mm

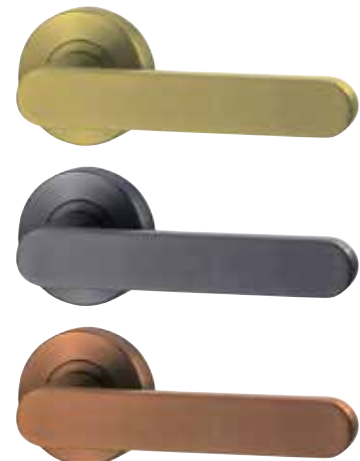
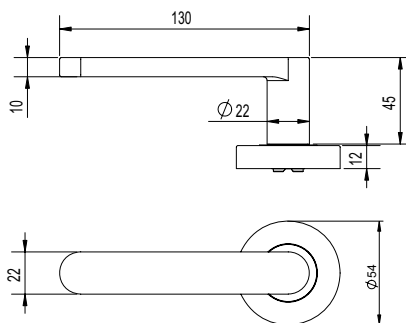

Vivid® Collection Internal Door Leversets

Lever 4 - Passage

Part Number
 VIV1/V4SBPVD
 VIV1/V4GMPVD
 VIV1/V4BZPVD

Length 130mm

Projection 53mm

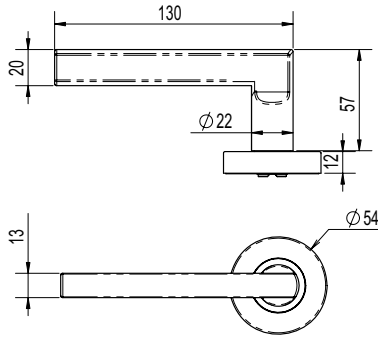

Lever 4 - Privacy

Part Number
 VIV2/V4SBPVD
 VIV2/V4GMPVD
 VIV2/V4BZPVD

Length 130mm

Projection 53mm

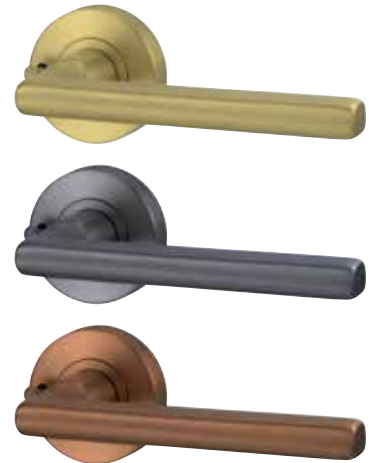
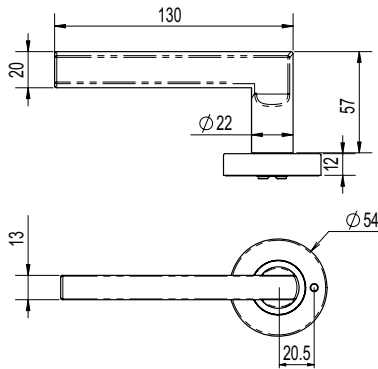

Lever 4 - Dummy

Part Number
 VIV3/V4SBPVD
 VIV3/V4GMPVD
 VIV3/V4BZPVD

Length 130mm

Projection 53mm

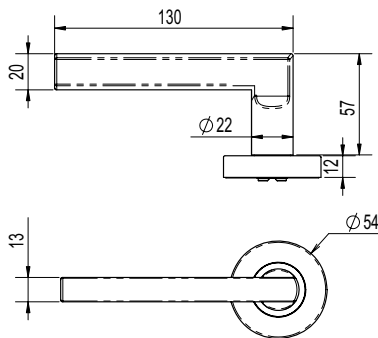

Vivid® Collection Internal Door Leversets

Vivid® Passage Set with Latch

Description	Quantity
Lever	2
Rose Trim	2
Passage Latch	1
Face Plate	1
Spindle	2
Spindle Springs	2
Through Fix Screws	2
Hex Inserts	2
Striker Plate with dust box	1
Timber Mounting screws	4

Vivid® Privacy Set with Latch

Description	Quantity
Lever	2
Rose Trim	2
Privacy Latch	1
Face Plate	1
Privacy Pin	1
Pointed tool	1
Spindle	2
Spindle Springs	2
Through Fix Screws	2
Hex Inserts	2
Striker Plate with dust box	1
Timber Mounting screws	4

Vivid® Half Dummy Lever

Description	Quantity
Lever	1
Rose Trim	1
Timber Mounting screws	4

Metal Finishes

For Metal Finish sample refer to code under each image.



Antique Copper (AC)
Sample Code: FIN-SAMPLEAC*



Architectural Bronze Unlacquered (AU)
Sample Code: FIN-SAMPLEAU*



Oil Rubbed Bronze (ORB)
Sample Code: FIN-SAMPLEORB*



Aged Brass (AG)
Sample Code: FIN-SAMPLEAG*

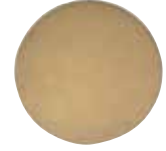

Architectural Bronze (AZ)
Sample Code: FIN-SAMPLEAZ**



Polished Brass (PB)
Sample Code: FIN-SAMPLEPB**



Satin Brass (SB)
Sample Code: FIN-SAMPLESB**



Polished Brass Unlacquered (BU)
Sample Code: FIN-SAMPLEBU*



Satin Brass Unlacquered (SBU)
Sample Code: FIN-SAMPLESBU*



Satin Chrome Plating (SC)
Sample Code: FIN-SAMPLESC



Chrome Plating (CP)
Sample Code: FIN-SAMPLECP



Stainless Steel (SS)
Sample Code: FIN-SAMPLESS



Polished Stainless Steel (PS)
Sample Code: FIN-SAMPLEPS



Natural Anodized Aluminium (NT)
Sample Code: FIN-SAMPLENT

NOTE: Not all decorative finishes apply to every Lockwood product. Refer to the table at the end of this document for specific decorative finishes applicable per series.

*Unlacquered Metal Finish. This finish will naturally age and its appearance will change over time according to the environment and use it is exposed to. For more information on the aging effect of a particular finish contact your ASSA ABLOY representative.

**Finish is protected by a top clear lacquer.

Disclaimer: Product Colours displayed in this catalogue have been matched to indoor viewing and colour appearance may vary according to light source and medium and as such should be used as indicative only. As actual colour on the end product may vary, always confirm your colour choice with production line prepared samples from your ASSA ABLOY representative for final colour approval. For warranty terms and conditions on Lockwood Products and its finishes, please visit www.lockweb.com.au or call 1300WARRANTY

Dulux Powdercoat Finishes

For Powdercoat Finish sample order code:

FIN-SAMPLEPC specify the desired color from the images below when placing order.

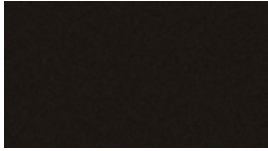

Dulux Duratec Eternity
Eternity Charcoal Pearl
Satin



Dulux Electro
Black Ace
Flat



Dulux Electro
Dark Bronze
Flat



Dulux Electro
Medium Bronze
Flat

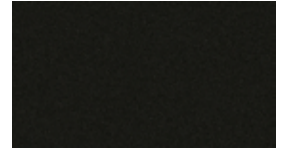

Dulux Precious
Charcoal Metallic Pearl
Gloss



Dulux Precious
Citi Pearl
Matt



Dulux Precious
Natural Pearl
Matt

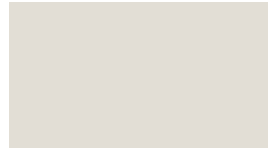

Dulux Duralloy
Shoji White
Satin



Dulux Alphatec
White
Matt

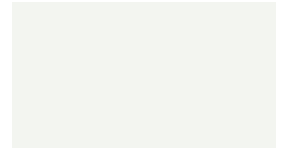

Dulux Duralloy
White
Satin

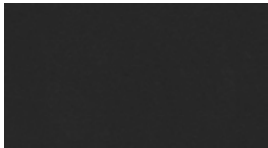

Dulux Surreal Effects Mannex
Mannex Black
Effect



Dulux Surreal Effects Scylla
Red Brown Scylla
Effect



Dulux Duralloy
Black
Gloss



Dulux Duralloy
Monument®
Satin



Dulux Duralloy
Black (C/B Night Sky®)
Satin

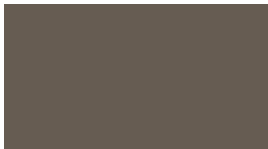

Dulux Duralloy
Jasper®
Satin

CB



Dulux Duralloy
Monument®
Matt

CB



Dulux Duralloy
Deep Ocean®
Satin

CB



Dulux Duralloy
Dune®
Satin

CB



Dulux Duralloy
Woodland Grey®
Satin

CB



Dulux Duralloy
Woodland Grey®
Matt

CB



Dulux Duralloy
APO Grey
Satin

NOTE: Not all Powdercoat Finishes apply to every Lockwood product. Refer to the notes at the end of this document for specific decorative finishes applicable per series.

CB Colorbond and the Colorbond colour names are registered trademarks of Bluescope Steel Limited



We recommend and use Dulux Powders

Disclaimer: Dulux, Duralloy, Anotec, Silver Kinetic, are registered trade marks of DuluxGroup (Australia) Pty Ltd. Monument, Night Sky, Dune, Woodland Grey, Jasper, Deep Ocean, Surfist, Pale Eucalypt, Paperbark, are registered trademarks of Bluescope Steel Limited. Product Colours displayed in this catalogue have been matched to indoor viewing and colour appearance may vary according to light source and medium and as such should be used as indicative only. As actual colour on the end product may vary, always confirm your colour choice with production line prepared samples from your ASSA ABLOY representative for final colour approval. For warranty terms and conditions on Lockwood Products and its finishes, please visit www.lockweb.com.au or call 1300WARRANTY

Dulux Powdercoat Finishes

For Powdercoat Finish sample order code:

FIN-SAMPLEPC specify the desired color from the images below when placing order.

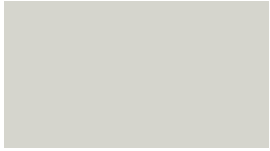

Dulux Duralloy
Surfmist®
Matt

CB



Dulux Duratec Eternity
Eternity Nickel Pearl
Matt



Dulux Duralloy
Anotec® Mid Bronze
Matt



Dulux Duralloy
Dune®
Matt

CB



Dulux Duralloy
Anotec® Dark Grey
Matt

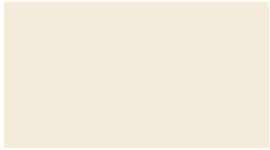

Dulux Duralloy
White Birch
Gloss



Dulux Duralloy
Stone Beige
Matt



Dulux Duralloy
Notre Dame
Gloss



Dulux Duralloy
Pale Eucalypt®
Satin

CB



Dulux Duralloy
Paperbark®
Satin

CB



Dulux Duralloy
Primrose
Gloss



Dulux Duralloy
Black (C/B Night Sky®)
Matt

CB

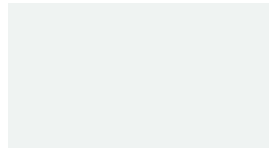

Dulux Duralloy
Pearl White
Gloss

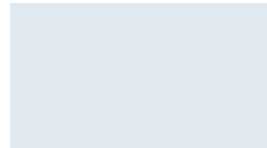

Dulux Duralloy
Bright White
Gloss

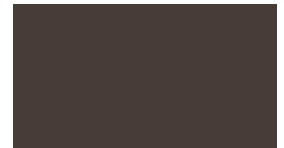

Dulux Duralloy
Hammersley Brown
Satin



Dulux Duralloy
Metropolis Storm Pearl
Satin



Dulux Duralloy
Charcoal
Satin

CB



Dulux Duralloy
Oyster
Matt



Dulux Duralloy
Berry Grey
Satin



Dulux Duralloy
Zeus Charcoal
Satin



Dulux Duralloy
Manor Red
Satin

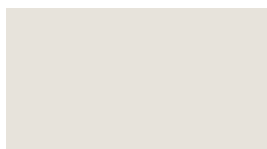

Dulux Duratec Zeus
Zeus Talc
Satin



Dulux Precious
Silver Kinetic Pearl
Satin

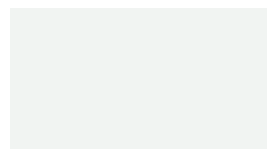

Dulux Charisma
Charisma Flat White
Flat

NOTE: Not all Powdercoat Finishes apply to every Lockwood product. Refer to the notes at the end of this document for specific decorative finishes applicable per series.

CB Colorbond and the Colorbond colour names are registered trademarks of Bluescope Steel Limited



We recommend and use Dulux Powders

Disclaimer: Dulux, Duralloy, Anotec, Silver Kinetic, are registered trade marks of DuluxGroup (Australia) Pty Ltd. Monument, Night Sky, Dune, Woodland Grey, Jasper, Deep Ocean, Surfist, Pale Eucalypt, Paperbark, are registered trademarks of Bluescope Steel Limited. Product Colours displayed in this catalogue have been matched to indoor viewing and colour appearance may vary according to light source and medium and as such should be used as indicative only. As actual colour on the end product may vary, always confirm your colour choice with production line prepared samples from your ASSA ABLLOY representative for final colour approval. For warranty terms and conditions on Lockwood Products and its finishes, please visit www.lockweb.com.au or call 1300WARRANTY

Interpon Powdercoat Finishes

For Powdercoat Finish sample order code:

FIN-SAMPLEPC specify the desired color from the images below when placing order.



Interpon Nuance
Silver Pearl
Satin



Interpon
Metallic Lustre
Matt



Interpon Vivica
Snow Dust
Matt



Interpon Sable
Core Ten
Fine Texture



Interpon Vivica
Ultra Silver
Gloss



Interpon Vivica
Storm Front
Matt



Interpon Hawthorn
Green
Gloss

NOTE: Not all Powdercoat Finishes apply to every Lockwood product. Refer to the notes at the end of this document for specific decorative finishes applicable per series.



We recommend and use Interpon Powders

Disclaimer: Interpon®, Sable™, Vivica™, Excel™ are registered trademarks of AkzoNobel Pty Ltd. Colors displayed on this color card are a guide only and have been matched as close as possible to Interpon production standards under daylight conditions. Due to the nature of the printing process some degree of color and gloss level variation may occur. Where more than one finish is available product color may vary. We recommend that you use production line prepared samples for final color selection or approval.

Decorative Finishes Per Series

Powdercoat Finishes

Rose Door Handles: Robert Watson, 1220, 1420, 1360, 1370, 260, 260SQ

Plate Door Handles: 1800, 2800, 4800, 5800, 200, 202, 212, 224

Push/Pull Plates: 218/219, 206/207, 208/209, 214/215, 216/217, 184, 185

Metal Finishes

Use table below as a reference for the applicable finish to each Lockwood Series.

Refer to the series catalogue for specific detailed information.

Reference Table									
	Brass Series Rose Door Handles 1220, 1420, 1360, 1370	Brass Series Plate Door Handles 1800, 2800, 4800, 5800	Artefact Series Rose Door Handles 260	Artefact Series Rose Door Handles 260SQ	Artefact Series Plate Door Handles 200, 202,	Artefact Series Plate Door Handles 212, 224	Push/Pull Plate Series 184, 185	Push/Pull Plate Series 214/215, 216/217, 218/219	Push/Pull Plate Series 206/207, 208/209
Antique Copper (AC)	✓	✓	✓	✗	✓	✗	✓	✓	✗
Architectural Bronze Unlacquered (AU)	✓	✓	✓	✗	✓	✗	✓	✓	✗
Oil Rubbed Bronze (ORB)	✓	✓	✓	✗	✓	✗	✓	✓	✗
Aged Brass (AG)	✓	✓	✓	✗	✓	✗	✓	✓	✗
Architectural Bronze (AZ)	✓	✓	✓	✗	✓	✗	✓	✓	✗
Polished Brass (PB)	✓	✓	✓	✗	✓	✗	✓	✓	✗
Satin Brass (SB)	✓	✓	✓	✗	✓	✗	✓	✓	✗
Polished Brass Unlacquered (BU)	✓	✓	✓	✗	✓	✗	✓	✓	✗
Satin Brass Unlacquered (SBU)	✓	✓	✓	✗	✓	✗	✓	✓	✗
Satin Chrome Plating (SC)	✓	✓	✗	✗	✗	✗	✓	✗	✗
Chrome Plating (CP)	✓	✓	✗	✗	✗	✗	✓	✗	✗
Stainless Steel (SS)	✗	✗	✓	✓	✓	✓	✗	✓	✓
Polished Stainless Steel (PS)	✗	✗	✓	✗	✓	✓	✗	✓	✓
Marine Grade Stainless Steel (MG)	✗	✗	✓	✗	✓	✓	✗	✓	✓
Natural Anodised Aluminium (NT)	✗	✗	✓	✗	✓	✓	✗	✗	✗

Disclaimer: Product Colours displayed in this catalogue have been matched to indoor viewing and colour appearance may vary according to light source and medium and as such should be used as indicative only. As actual colour on the end product may vary, always confirm your colour choice with production line prepared samples from your ASSA ABLOY representative for final colour approval. For warranty terms and conditions on Lockwood Products and its finishes, please visit www.lockweb.com.au or call 1300WARRANTY

Brass Furniture Series Special Finishes Pricing

Standard Finish

Satin chrome brushed (SC)

Non-Standard Finishes:

Mark-Up Over Standard Finish*

Chrome Plate (CP)	10%
Polished Brass (PB)	20%
Polished Brass Unlacquered (BU)	20%
Satin Brass (SB)	20%
Satin Brass Unlacquered (SBU)	20%
Polyester Powdercoat (PC)	20%
Architectural Bronze (AZ)	25%
Architectural Bronze Unlacquered (AU)	25%
Oil Rubbed Bronze (ORB)	25%
Aged Brass (AG)	25%
Antique Copper (AC)	25%

*Applicable to Brass Furniture Series 1220, 1420, 1360, 1370, 1800, 2800, 4800 and 5800 Product Ranges

Door Furniture Levers and Knob Options (Tier 1 Pricing)



20 Knob

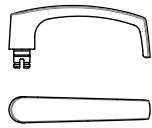

47 Lever

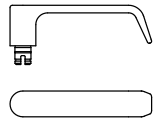

59 Lever

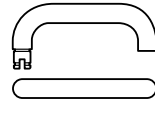

70 Lever

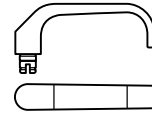

74 Lever

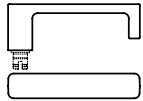

76 Lever

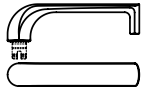

77 Lever

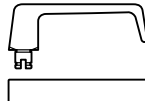

90 Lever

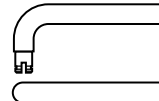

97 Lever

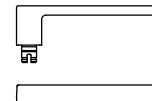

101 Lever

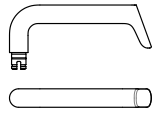

102 Lever

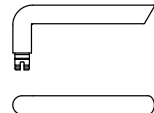

104 Lever

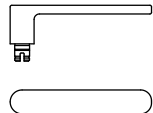

106 Lever

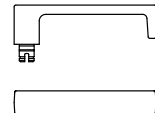

111 Lever

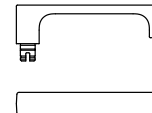

112 Lever

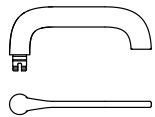

115 Lever

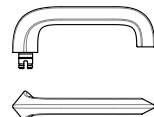

116 Lever

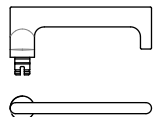

118 Lever

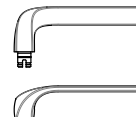

122 Lever

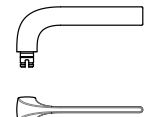

123 Lever

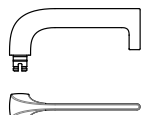

124 Lever

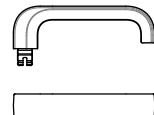

131 Lever

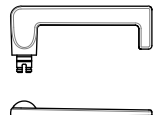

132 Lever

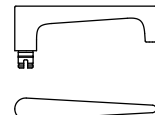

133 Lever

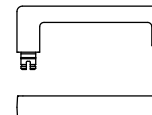

142 Lever

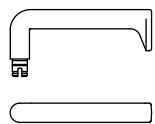

144 Lever

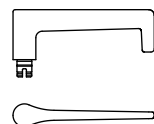

145 Lever

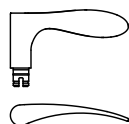

153 Lever

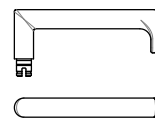

155 Lever

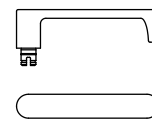

166 Lever

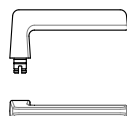

178 Lever

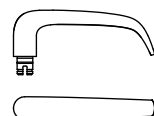

180 Lever



ASSA ABLOY

Lockwood is the leading brand in the Australian locking industry. With an established reputation for high quality products, this iconic brand provides a wide range of locking solutions to residential housing, commercial, semi-commercial, building and industrial application markets. Lockwood is supported by an extensive distribution and after-sales support network. Our customers include retailers, architects, trade and industrial personnel, locksmiths and security dealers.

ASSA ABLOY is the global leader in door opening solutions, dedicated to satisfying end-user needs for security, safety and convenience.

ASSA ABLOY is represented in all major regions, in both mature and emerging markets, with leading positions in Australia, Europe and North America.

**25YEAR
MECHANICAL
WARRANTY**

The Lockwood 25 Year Mechanical Warranty

Our belief that we manufacture the finest premium products available in today's market place is backed by the Lockwood 25 Year Mechanical Warranty, ensuring that Lockwood continues to keep Australians safe by delivering security and peace of mind.

For warranty terms and conditions, please visit www.lockweb.com.au or call **1300WARRANTY**

ASSA ABLOY Opening Solutions Australia
235 Huntingdale Road
Oakleigh, Victoria, 3166
Australia

1300 LOCK UP (1300 562 587)
lockweb.com.au

ASSA ABLOY New Zealand Ltd
6 Armstrong Road
Albany, Auckland, 0632
New Zealand

nzsales@assaabloy.com
Telephone +64 9415 7111
assaabloyopeningsolutions.nz

Disclaimer

Whilst every effort has been made to ensure that the information (including product images and drawings) contained in this brochure is accurate at the time of publication, ASSA ABLOY Australia Pty Limited ("ASSA ABLOY") recommends that you consult ASSA ABLOY or its agents prior to placing an order to ascertain current information on specific products, as ASSA ABLOY reserves the right to make changes without notice. ASSA ABLOY will not be liable for any injury, loss or damage whatsoever, arising from any errors or omissions in the information contained in the brochure or arising from the use or application of the information contained herein. © 2023 copyright by ASSA ABLOY All rights reserved

