

BUSTER+PUNCH

LONDON

[product.]

PULL BAR / PLATE / CROSS

[type. **PULL BAR.**]

[knurl. **CROSS.**]

[detail. **COIN SCREW.**]

A pull bar made from solid brass. This pull bar features our signature, diamond-cut, cross-knurl pattern and is refined by hand. They work great on cabinet doors, wardrobe drawers, cupboards, kitchen units and just about anything that can open. Available in 4 metal finishes: steel, brass, smoked bronze and black.



[type. **PULL BAR / PLATE / SMALL.**]

[info. **MEASUREMENTS.**]

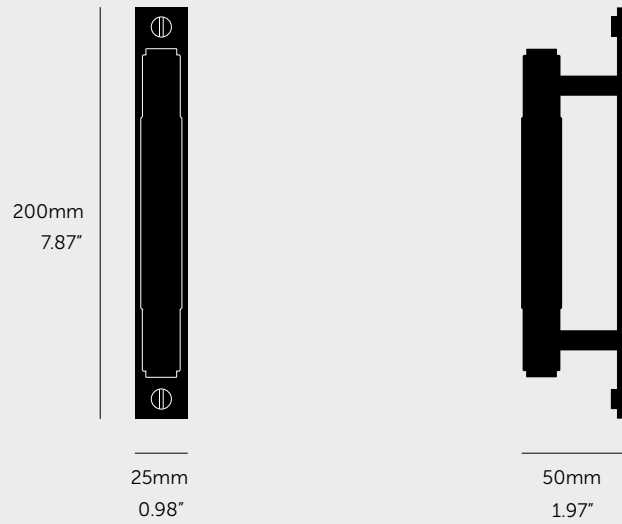

[info. **SPECIFICATIONS.**]

Rear Fixing

Fits doors of:

Max 20mm or ²⁵/₃₂"*





*For thicker doors you will need to source longer M5 screws

[info. **FINISH & SKU NUMBERS.**]

[finish.]

[UK.]

[US.]

 Steel	UK-PB-HP-160-ST-A	US-PB-HP-6.3-ST-A
 Brass	UK-PB-HP-160-BR-A	US-PB-HP-6.3-BR-A
 Smoked Bronze	UK-PB-HP-160-SM-A	US-PB-HP-6.3-SM-A
 Black	UK-PB-HP-160-BL-A	US-PB-HP-6.3-BL-A

[info. **CARE INSTRUCTIONS.**]

Wipe with damp cloth with no loose hairs, avoid using any chemicals. All finishes are prone to aging.

[info. **INCLUDED.**]

1 x Pull Bar

1x Back Plate

2x Coin Screws

2x M5 x 30 mm screws

2x M5 washers

[please. **NOTE.**]

DISCLAIMER: Always consult a trade professional when installing these pull bars. Buster + Punch is not responsible for the usage or feasibility of installation requirements. This product is not suitable for damp or wet environments.

[type. **PULL BAR / PLATE / MEDIUM.**]

[info. **MEASUREMENTS.**]

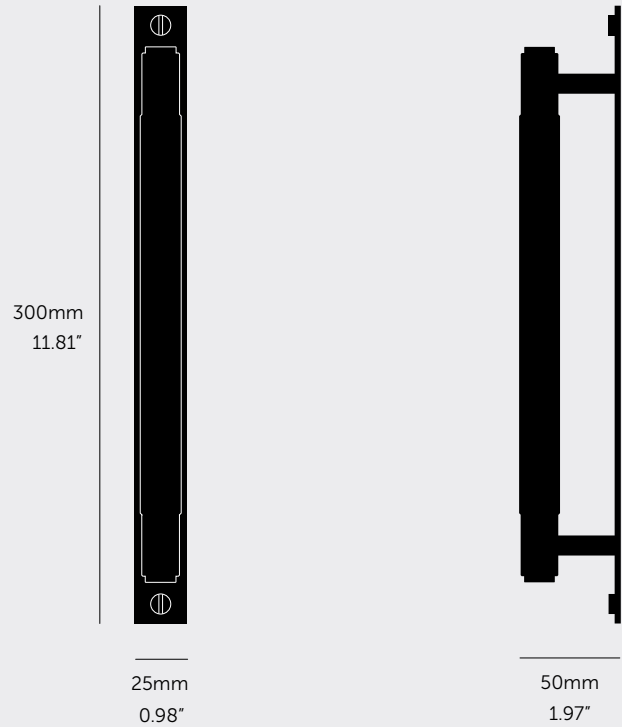

[info. **SPECIFICATIONS.**]

Rear Fixing

Fits doors of:

Max 20mm or ²⁵/₃₂"*





*For thicker doors you will need to source longer M5 screws

[info. **FINISH & SKU NUMBERS.**]

[finish.]

[UK.]

[US.]

 Steel	UK-PB-HP-260-ST-A	US-PB-HP-10.2-ST-A
 Brass	UK-PB-HP-260-BR-A	US-PB-HP-10.2-BR-A
 Smoked Bronze	UK-PB-HP-260-SM-A	US-PB-HP-10.2-SM-A
 Black	UK-PB-HP-260-BL-A	US-PB-HP-10.2-BL-A

[info. **CARE INSTRUCTIONS.**]

Wipe with damp cloth with no loose hairs, avoid using any chemicals. All finishes are prone to aging.

[info. **INCLUDED.**]

1 x Pull Bar

1x Back Plate

2x Coin Screws

2x M5 x 30 mm screws

2x M5 washers

[please. **NOTE.**]

DISCLAIMER: Always consult a trade professional when installing these pull bars. Buster + Punch is not responsible for the usage or feasibility of installation requirements. This product is not suitable for damp or wet environments.

[type. **PULL BAR / PLATE / LARGE.**]

[info. **MEASUREMENTS.**]

400mm
15.75"



25mm
0.98"



50mm
1.97"

[info. **SPECIFICATIONS.**]

Rear Fixing

Fits doors of:

Max 20mm or ²⁵/₃₂"*





*For thicker doors you will need to source longer M5 screws

[info. **FINISH & SKU NUMBERS.**]

[finish.]

[UK.]

[US.]

 Steel	UK-PB-HP-360-ST-A	US-PB-HP-14.2-ST-A
 Brass	UK-PB-HP-360-BR-A	US-PB-HP-14.2-BR-A
 Smoked Bronze	UK-PB-HP-360-SM-A	US-PB-HP-14.2-SM-A
 Black	UK-PB-HP-360-BL-A	US-PB-HP-14.2-BL-A

[info. **CARE INSTRUCTIONS.**]

Wipe with damp cloth with no loose hairs, avoid using any chemicals. All finishes are prone to aging.

[info. **INCLUDED.**]

1 x Pull Bar

1x Back Plate

2x Coin Screws

2x M5 x 30 mm screws

2x M5 washers

[please. **NOTE.**]

DISCLAIMER: Always consult a trade professional when installing these pull bars. Buster + Punch is not responsible for the usage or feasibility of installation requirements. This product is not suitable for damp or wet environments.