

BUSTER+PUNCH

LONDON

[product.]

1G DIMMER SWITCH

[range. **ELECTRICITY.**]

[knurl. **CROSS.**]

[detail. **COIN SCREWS.**]

A dimmer switch with a tactile diamond-cut, knurled knob. The dimmer is finished with a solid metal flat plate and our signature coin screws. Available in four different finishes, or customisable with a range detail kits to suit any interior. They can be used in combination with our matching toggle switches and outlets.



[type. **DIMMER SWITCH.**]

[info. **MEASUREMENTS.**]

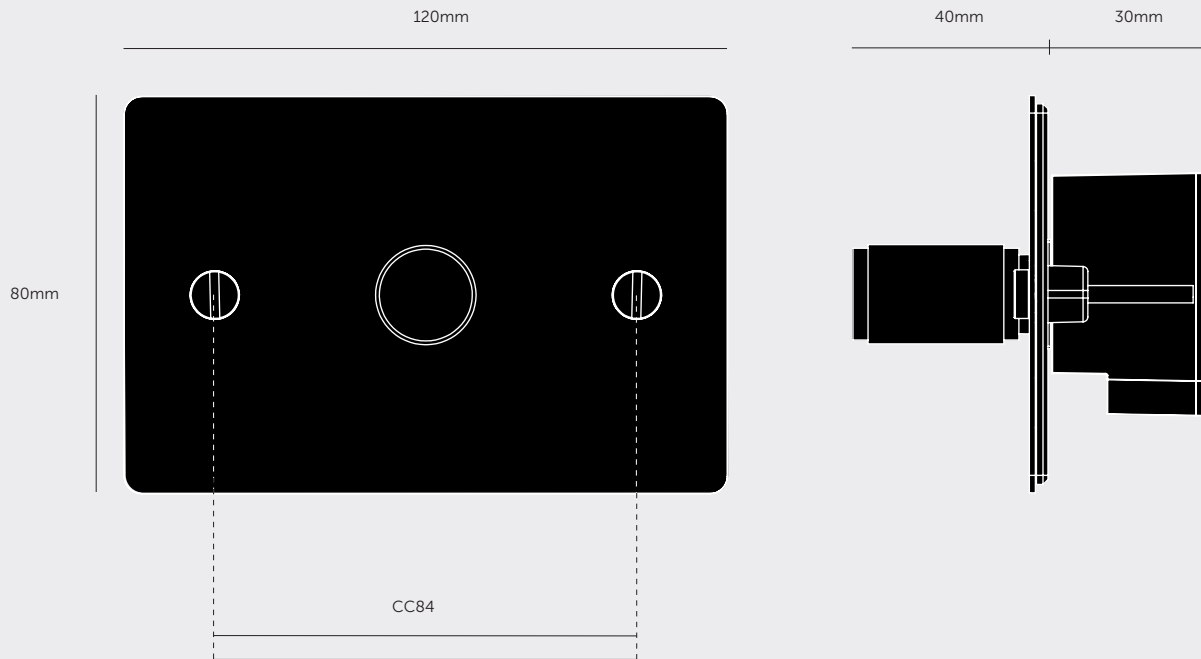

***DETAILS KITS AVAILABLE TO CREATE MIXED FINISHES**

[info. **SPECIFICATIONS.**]

Single Rotary Dimmer

Module Code: Dim-002

Style: ON/OFF Auto Detect Intelligent Dimmer Module

Input: 230-240 VAC / 50 Hz

Dimming Type: Leading / Trailing Edge

Load: Hal/Inc 10-300W max. / LED 150W max.

Operating Temperature: 0° - 45°C / 32° - 113°F





Backbox: Standard 2G.

Allow depth of module + sufficient space for connections when choosing a backbox.





[info. **CARE INSTRUCTIONS.**]

Wipe with damp cloth with no loose hairs, avoid using any chemicals. Please note all finishes are prone to aging.

[info. **FINISH & SKU NUMBERS.**]

| [finish.] | [sku.] |
|---|-----------|
|  Steel | ZDR-07445 |
|  Brass | ZDR-05444 |
|  Smoked Bronze | ZDR-09446 |
|  Black | ZDR-02443 |

[info. **DETAIL KIT & SKU NUMBERS.**]

| [finish.] | [sku.] |
|---|-----------|
|  Steel | ZDK-07637 |
|  Brass | ZDK-05636 |
|  Smoked Bronze | ZDK-09638 |
|  Black | ZDK-02635 |

BUSTER+PUNCH

LONDON

[product.]

2G DIMMER SWITCH

[range. **ELECTRICITY.**]

[knurl. **CROSS.**]

[detail. **COIN SCREWS.**]

A dimmer switch with a tactile diamond-cut, knurled knob. The dimmer is finished with a solid metal flat plate and our signature coin screws. Available in four different finishes, or customisable with a range detail kits to suit any interior. They can be used in combination with our matching toggle switches and outlets.



[type. **DIMMER SWITCH.**]

[info. **MEASUREMENTS.**]

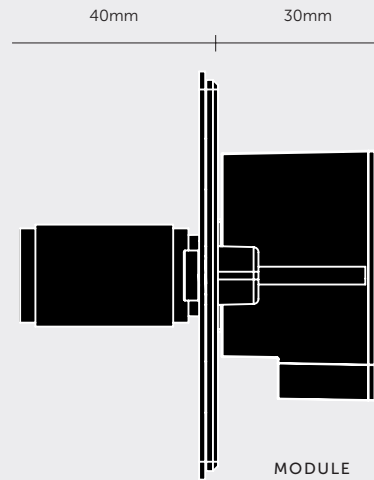
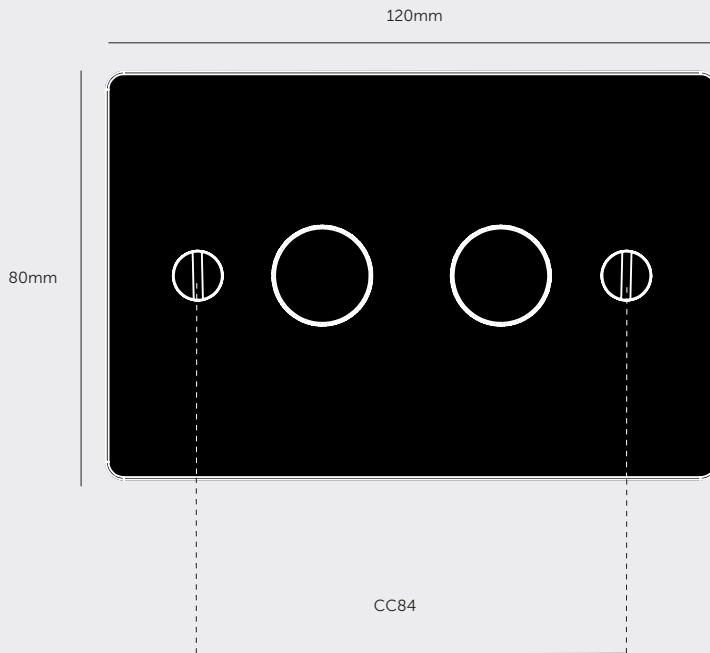

***DETAILS KITS AVAILABLE TO CREATE MIXED FINISHES**

[info. **SPECIFICATIONS.**]

Double Rotary Dimmer

Module Code: Dim-002

Style: ON/OFF Auto Detect Intelligent Dimmer Module

Input: 230-240 VAC / 50 Hz

Dimming Type: Leading / Trailing Edge

Load: Hal/Inc 10-300W max. / LED 150W max. (each)

Operating Temperature: 0° - 45°C / 32° - 113°F





Backbox: Standard 2G.

Allow depth of module + sufficient space for connections when choosing a backbox.





[info. **CARE INSTRUCTIONS.**]

Wipe with damp cloth with no loose hairs, avoid using any chemicals. Please note all finishes are prone to aging.

[info. **FINISH & SKU NUMBERS.**]

| [finish.] | [sku.] |
|---|-----------|
|  Steel | ZDR-07450 |
|  Brass | ZDR-05449 |
|  Smoked Bronze | ZDR-09451 |
|  Black | ZDR-02448 |

[info. **DETAIL KIT & SKU NUMBERS.**]

| [finish.] | [sku.] |
|---|-----------|
|  Steel | ZDK-07637 |
|  Brass | ZDK-05636 |
|  Smoked Bronze | ZDK-09638 |
|  Black | ZDK-02635 |

HOW TO BUILD YOUR CUSTOM DIMMER SWITCH

[range. **ELECTRICITY.**]

[knurl. **CROSS.**]

[detail. **COIN SCREWS.**]

All products are available in solid finishes, customisable with interchangeable details kits to suit any interior. Requires appropriate details kit.

1

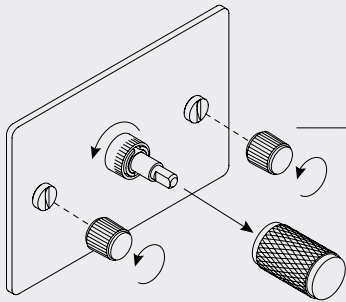

REMOVE PRE-FITTED COIN SCREWS & DIMMER KNOB.

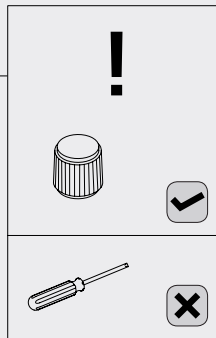

2

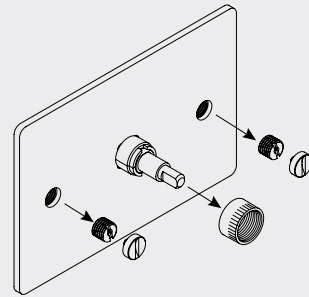

3

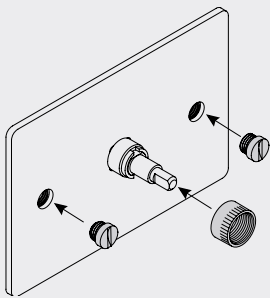

REPLACE WITH COIN SCREWS & DIMMER KNOB FROM YOUR DETAILS KIT.

4

