



TS 7000 Door Spring

PS180 Double Action & PS170 Single Action Kits

CE 703.1
1121
BS EN 1154
4 8 3 1 1 3

www.rutlanduk.co.uk

PS 180 Double Action Door Kit

1 Fit Cement Box (Plan View)

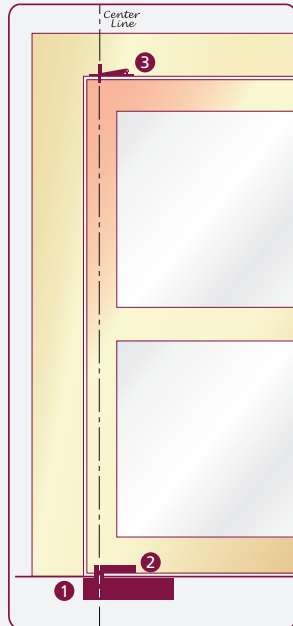
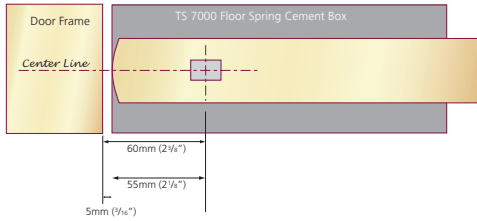

2 Bottom Door Fitting (Side View)

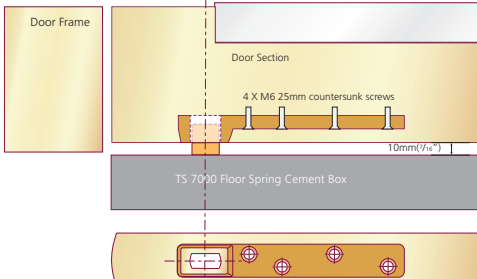

Bottom Door Fitting (Bottom View)

3 Top Door Fitting (Side View)

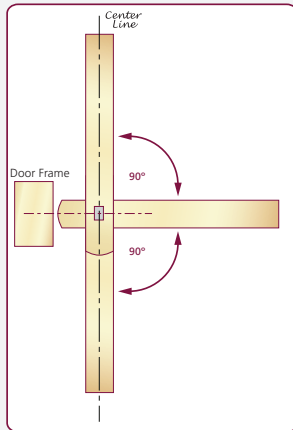
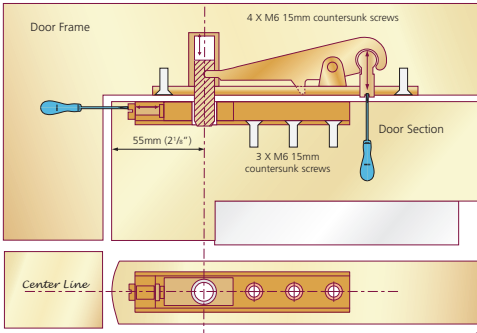

2-4 Power Adjustment

Model/Unit	EN Size	Max. weight kg	Max. door width	Max. opening angle
TS 7002	2	70	850mm	130°
TS 7003	3	105	950mm	130°
TS 7004	4	150	1150mm	130°

TS 7000 Door Spring

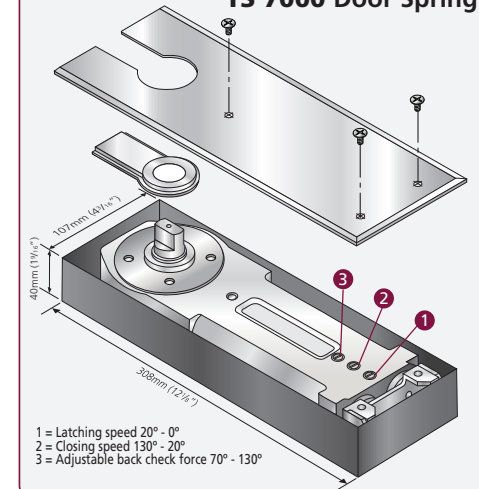

- 1 = Latching speed 20° - 0°
- 2 = Closing speed 130° - 20°
- 3 = Adjustable back check force 70° - 130°

PS 170 Single Action Door Kit

1 Fit Cement Box and bottom hinge (Plan View)

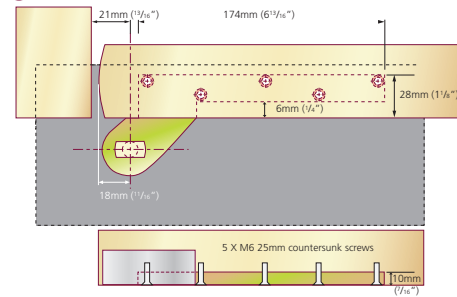

2 Fit top hinges to door and door frame

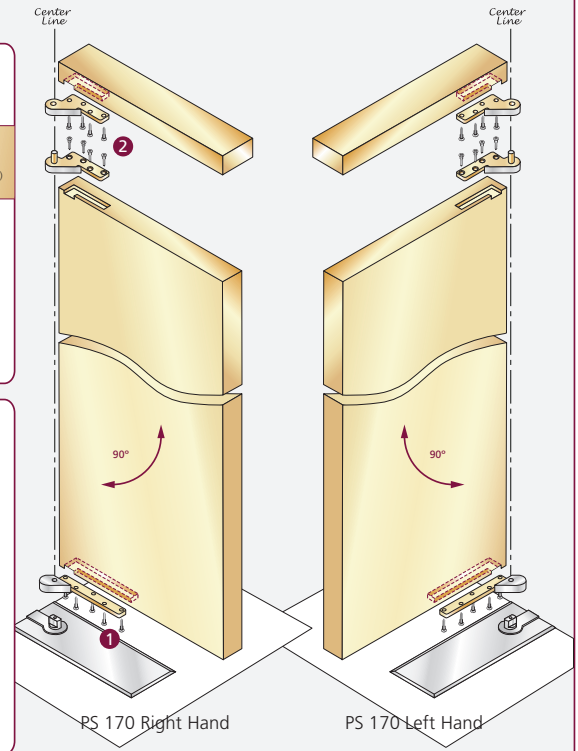
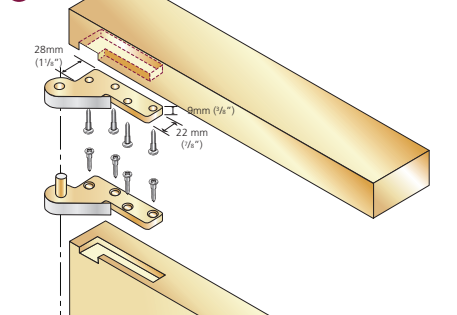

PS 170 Right Hand

PS 170 Left Hand